

High Bandwidth full NDI PTZ

User Manual Ver 1.00



Contents

Caution.....	4
Introduction.....	6
Features	6
Products & Accessories	8
Ceiling Mount Bracket (ZCB-100) Installation.....	9
Wall Mount Bracket (ZWB-200) Installation	10
Installation	11
① Camera Address-ADRESS Setup	12
② Communication Protocol-PROTOCOL Setup.....	12
③ Output Video Format-SYSTEM SELECT Setup.....	13
④ Communication Type-COMMUNICATION Setup	14
⑤ Connection.....	15
- N:N camera connection using RJ-45 LAN (RS-422).....	17
- 1:N camera connection using RJ-45 LAN (RS-422)	18
⑥ Installation Check.....	19
⑦ Power	19
Main Features.....	20
Screen Menu	20
PRESET	21
SWING	22
PATTERN.....	22
GROUP.....	23
Other Functions.....	23
Menu Function	24
OSD (On Screen Display) Configuration	24
Main Menu.....	25
① Focus/Zoom.....	25
② White Balance	26
③ Auto Exposure.....	26
④ Picture.....	27
⑤ Image	28
⑥ Motion/Action.....	28
Motion	29

PT Speed Setup.....	30
Home Position Setup.....	30
North Direction Setup	30
Preset Setting	31
Edit Scene- Preset Setup	31
Edit Label-Preset Setup	32
Swing Setup	32
Pattern Setup.....	33
Group Setup.....	33
Edit Group-Group Setup.....	34
Parking Action Setup	35
7 Display Setup.....	35
Area Label Setup.....	36
Edit Scene.....	37
Edit Label.....	38
Area Label Setup.....	38
8 System Info.....	39
Additional Info.....	39
System Initialize	40
IR Remote Control	41
NDI Finder application.....	44
BASIC.....	44
NDI Web-Server	47
Controller	50
Problem Solving.....	52
Menu Structure	53
Default Value.....	56
Specifications.....	58
Dimension	60
Glossary.....	63
Index	65

Caution



Caution

Don't open. There may be electric shock.



Caution

To avoid the risk of electric shock, do not arbitrarily open the cover or disassemble the product. There are no user serviceable replacement parts. Get service from qualified service personnel.



This lightning flash with arrowhead symbol is intended to alert the user to the presence of un-insulated "dangerous voltage" within the product's enclosure that may be of sufficient magnitude to constitute a risk of electric shock to person.



This exclamation point symbol is intended to alert the user to the presence of important operating and maintenance (servicing) instructions in the literature accompanying the appliance.

Caution

This symbol indicates to the user that this is important for operation or maintenance of the product.

Safety Precautions

- ◆ Read all of the safety and operating instructions before using the product.
- ◆ Save these instructions for future reference.
- ◆ Do not use attachments or accessories unless recommended by the appliance manufacturer as they may cause hazards, damage product and void warranty.
- ◆ Do not use this product near water or moisture.
- ◆ Do not place or mount this product in or on an unstable or improperly supported location.
- ◆ Improperly installed product may fall, causing serious injury to a child or adult, and damage to the product. Use only with a mounting device recommended by the manufacturer, or sold with the product. To insure proper mounting, follow the manufacturer's instructions and use only mounting accessories recommended by manufacturer.
- ◆ This product should be operated only from the type of power source indicated on the marking label.

Precautions

- ◆ Before using, make sure power supply and others are properly connected.
- ◆ While operating, if any abnormal condition or malfunction is observed, stop using the camera immediately and then contact your local dealer.
- ◆ Do not disassemble or tamper with parts inside the camera.
- ◆ Do not drop or subject the camera to shock and vibration as this can damage camera.
- ◆ Care must be taken when you clean the clear dome cover. Especially, scratch and dust will ruin your quality of camera.
- ◆ Do not install the camera in areas of extreme temperature, which exceed the allowable range.
- ◆ Avoid installing in humid or dusty places.
- ◆ Never expose the camera to rain and water.
- ◆ Avoid installation in a place with radioactivity. It may cause a malfunction of the part.
- ◆ Avoid installation in locations with strong magnetic fields or electrical signals.
- ◆ Avoid installing in places where the camera would be subject to strong vibrations.

Precautions for Laser Beam

- ◆ Laser beam can damage CMOS. When shooting a scene where laser beam is involved, do not let the beam contacts the CMOS directly.

Introduction

Features

Optical x20/X30 Zoom Lens

SHARON 20 : 1/2.8 inch, 2.12 mega pixels "Exmor R" CMOS Sensor

Supports Max. x20 including digital x12 zoom

SHARON 30 : 1/2.8 inch, 2.38 mega pixels "Exmor R" CMOS Sensor Sony Zoom Module

Supports Max. x30 including digital x12 zoom

Full HD Output Format

Various format of HD video output is available and Max. 1920x1080p60 is supported.

1080p	60/59.94/50/30/25
1080i	60/59.94/50
720p	60/59.94/50/30/25

Audio

Supports the Stereo Audio.

Simultaneous Output Video Interface

Various output is available such as High Bandwidth NDI, 3G-SDI, HDMI and for multi-monitoring, simultaneous output is supported.

Select multiple protocols and communication types

VISCA, PELCO-D/P	RS-232C, RS-422/485
------------------	---------------------

Powerful Pan/ Tilt Function

Pan: -172°~ 172° (Non-Endless), Tilt: total 220°(-20°~ 0°~ 180°~ -160°)

Smart Flip Function

This function extend the shooting range by setting the camera to flip the image automatically when it tilts over 90°.

→ When Smart Flip function is enabled, **F** letter will be shown in the display.

Infrared Cut Filter (IR CUT-Filter) applied

In order to improve the sensitivity by keeping the light absorption time longer at low light level such as at night, Slow shutter function and Day & Night switching function are provided so that users can select color change according to illumination.

Various Presets & Auto Pan/ Tilt Function

Max. 255 assignable presets are supported to save various settings. Also, the CCTV functions like Swing, Pattern, and Group functions are available for novice users to make stable pan / tilt operation through preset values.

OSD(On Screen Display) Menu Support

Enables you to edit detailed settings using the OSD menu.

※ Refer to Page 52 “Menu Structure” to check the menu tree.

***ALL PRODUCT, PRODUCT SPECIFICATIONS AND DATA ARE SUBJECT TO CHANGE WITHOUT NOTICE TO IMPROVE RELIABILITY, FUNCTION OR DESIGN OR OTHERWISE.**

*** NDI[®] are registered trademarks in the United States and other countries by NewTek.**

Products & Accessories

- Basic Components

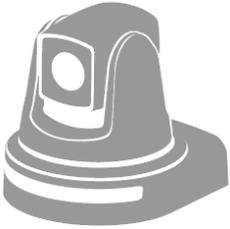
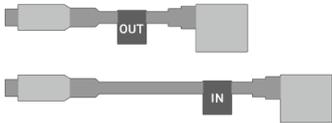
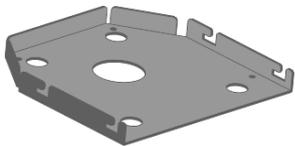
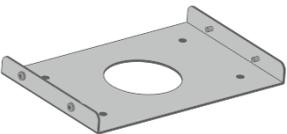
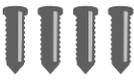
		
Camera	IR remote (with battery)	Camera Bracket Screw
		
User Manual	AC Adapter	1m RJ45 Cable(Direct)
		
232C to UTP Cable	9p to UTP Cable	
		
Camera Bracket	Ceiling Bracket	
		
Ceiling Bracket Screw	Plastic Anchor	Camera body/ Ceiling Bracket Screw

■ Ceiling Mount Bracket (ZCB-100) Installation

- Ceiling bracket installation method

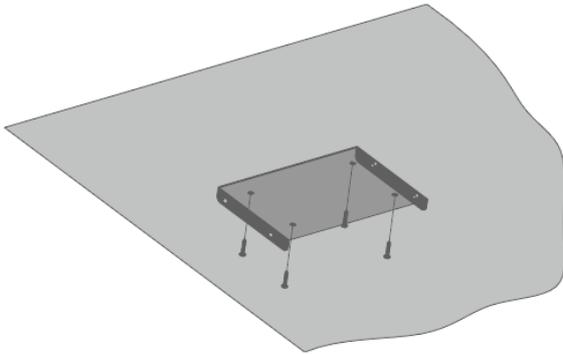

1) Fix the ceiling bracket on the ceiling using the screws (4EA).

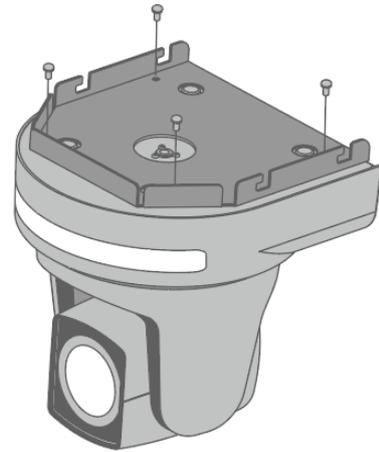

2) Attach the bracket to the camera body as shown in the picture using the camera bracket and screws (4EA).



3) Insert the camera bracket into the ceiling bracket's groove as shown in the picture.

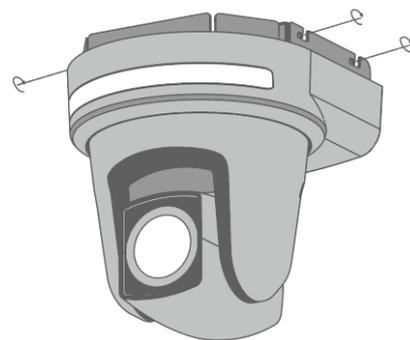

4) Tighten the screws (4EA) on all four sides to fix the camera.

Wall Mount Bracket (ZWB-200) Installation

● ZWB-200 Components (Optional)

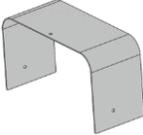
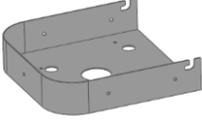
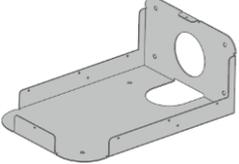
			
Cover	Camera bracket	Wall bracket	
			
Wall bracket screws	Plastic anchor (For fastening wall screws)	Camera screws	Bracket screws

● Installation Method

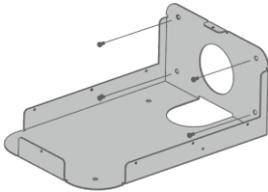

1) Fix the Wall bracket on the wall using the wall bracket screws (4EA).

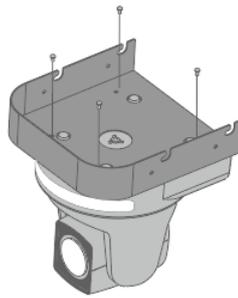

2) Attach the bracket to the camera body as shown in the picture using the camera bracket and screws (4EA).

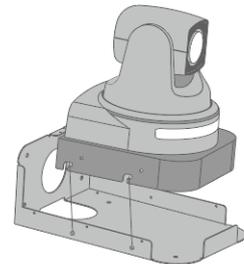

3) Insert the camera body into the wall bracket's groove as shown in the picture.

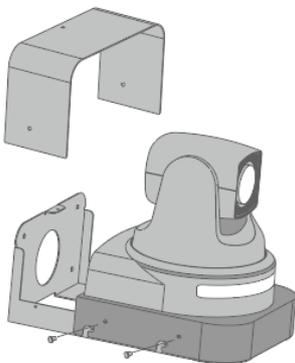

4) Fix the camera bracket with screws (4EA)

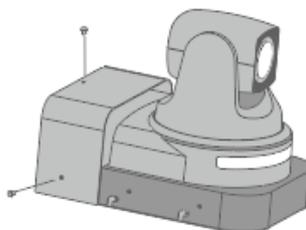

5) Attach the cover with screws (3EA).

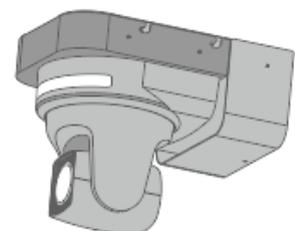

6) Installation complete

Installation

- SHARON 30/20 Rear-Side

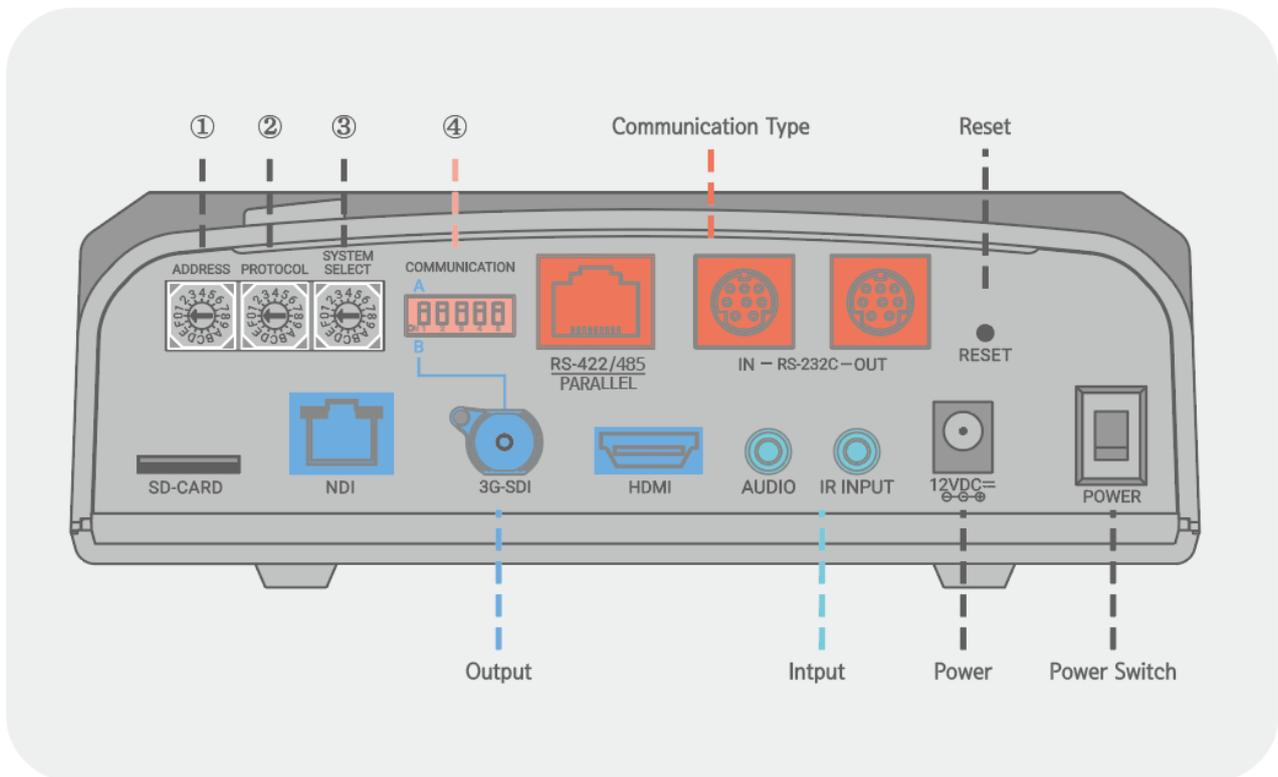

① Camera Address-ADDRESS Setup

Change the Camera ID as shown below.



- Up to 14 addresses can be set to control multiple cameras.

※ Do not use Number 0 and 15(F).

- Factory default is set to 1.

When operating multiple cameras with the controller, set the different ID for each camera.

* It is recommended to use a micro driver to make changes.

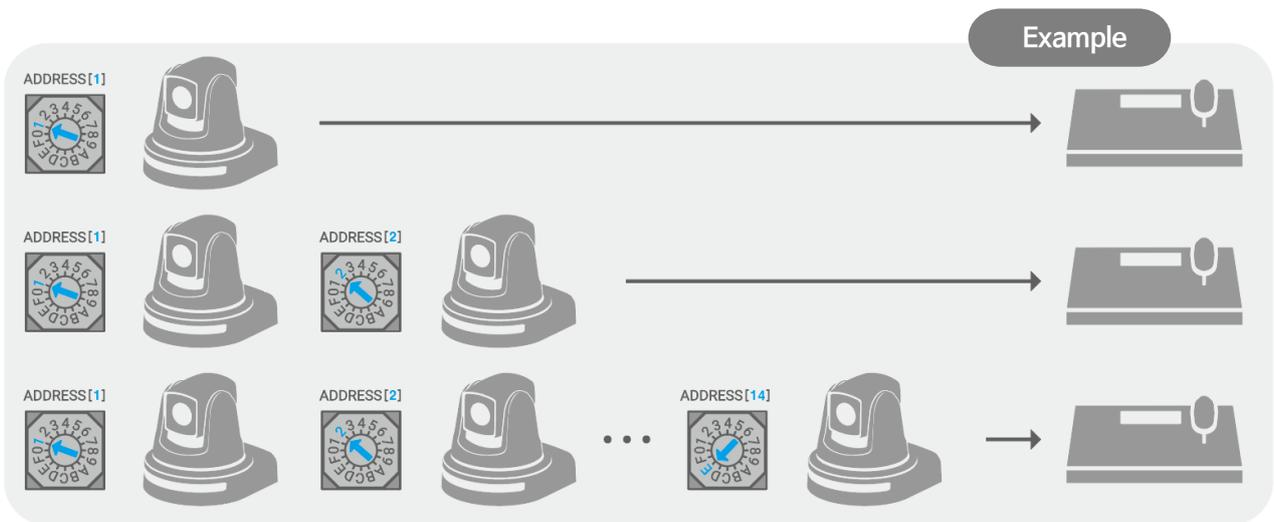

② Communication Protocol-PROTOCOL Setup

Change the communication protocol as shown below.



Factory Default:



Protocol	BAUDRATE	Switch
VISCA	9600 bps	0
	38400 bps	1
PELCO-D	2400 bps	2
	9600 bps	3
	38400 bps	4
PELCO-P	4800 bps	5
	9600 bps	6

Set the protocol correspond to the controller.

Be sure to change the protocol while the power is off.

③ Output Video Format-SYSTEM SELECT Setup

Set the video output format by changing the switch as shown below.

Factory Default: 



Output Video Format	Switch	Output Video Format	Switch
1920x1080p60	0	1920x1080p50	8
1920x1080i60	1	1920x1080i50	9
1920x1080p30	2	1920x 1080p25	A
1280x720p60	3	1280x720p50	B
1280x720p30	4	1280x 720p25	C
1920x1080p59.94	5	Reserved	D
1920x1080i59.94	6		E
1280x720p59.94	7		F

Make sure to change the format while the power is off.

- HDMI and HD/3G-SDI simultaneous output.

④ Communication Type-COMMUNICATION Setup

* The RS-232C/RS-422/RS-485 communication is available without setting the DIP Switch separately.

* Do not mix the 232C / RS-422 (Parallel) / RS-422 (Daisy) communication methods. There may be a problem with the operation of the product.

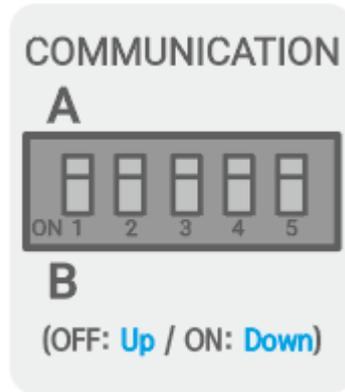

* Set the terminating resistance by selecting DIP switches 4 (Rx) and 5 (Tx) as ON / OFF as follows.

- When using RS-485, terminating resistance is used in the following cases.

Very long communication connection between controller and camera(1: 1 connection)

If the distance between the controller and the camera is very long, communication problems may occur due to the impedance problem of the communication line.
In this case, set the terminating resistance to ON for both controller and camera.

When multiple cameras are connected at the same time (1: N connection)

If you connect multiple cameras simultaneously to one controller, communication failure may occur. In this case, set the terminating resistance of the controller to ON, and set the terminating resistance of only one camera on the end to ON.

※ Never set the terminating resistance of all cameras to ON.

* The default setting of terminating resistance is OFF.
(Set terminating resistance when communication error occurs.)

⑤ Connection

Connect a controller that transmits and receives PTZ control commands.

- RS-232C Connection (232C to RJ45 Cable, RJ45 Cable)

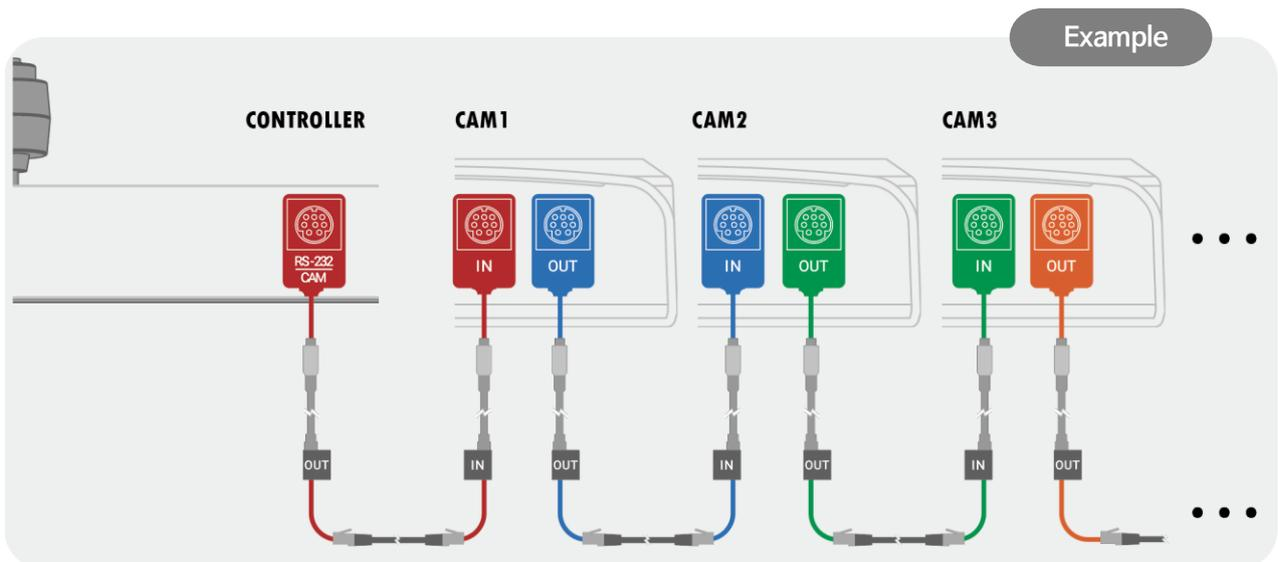
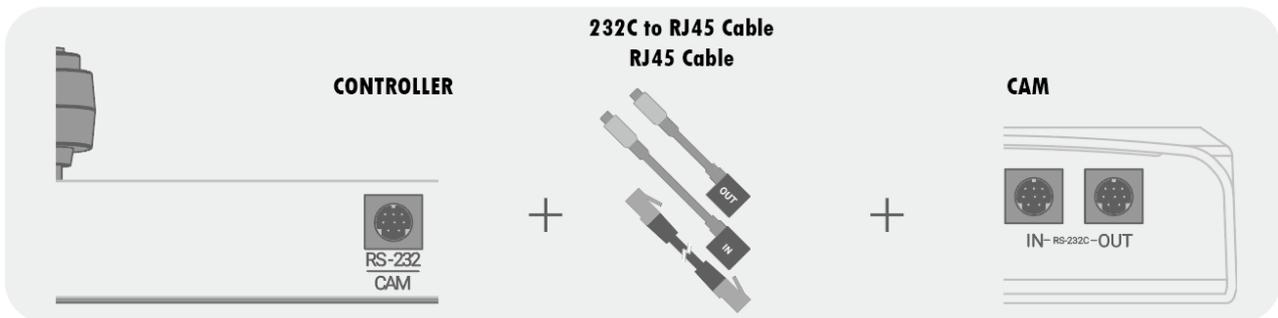

1. Connection of Controller and Camera

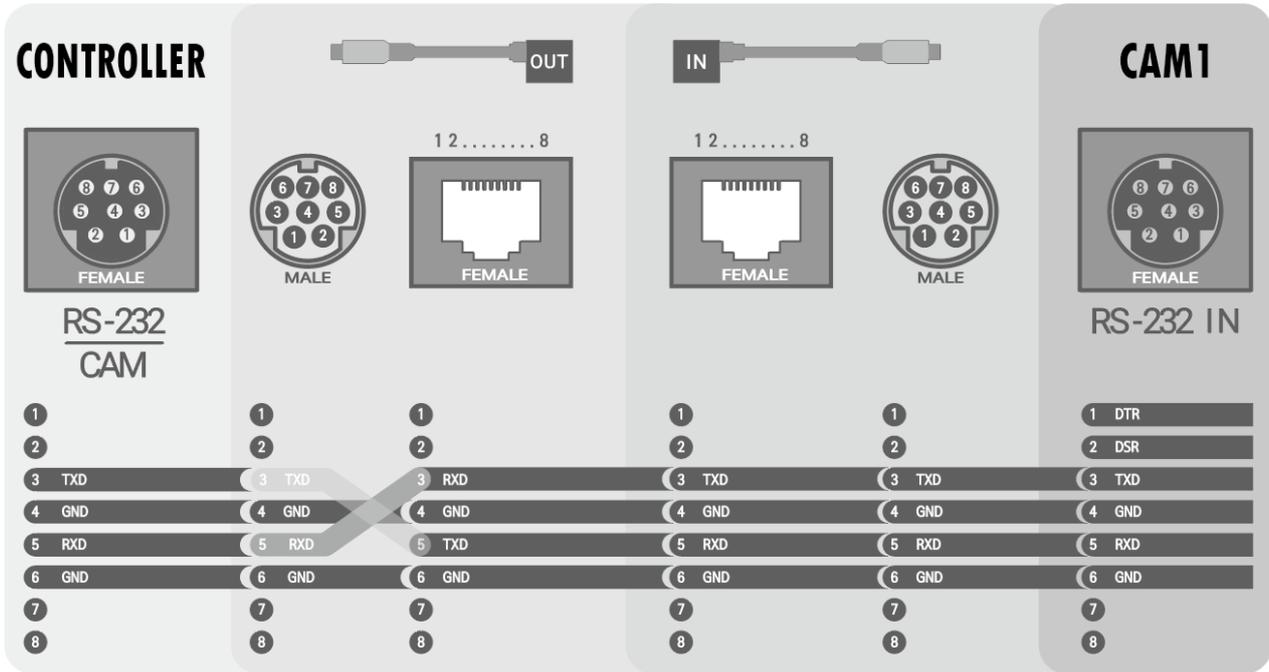

* Connect the 232 IN / 232 OUT cable using the direct LAN cable.

2. Multiple Camera Connection

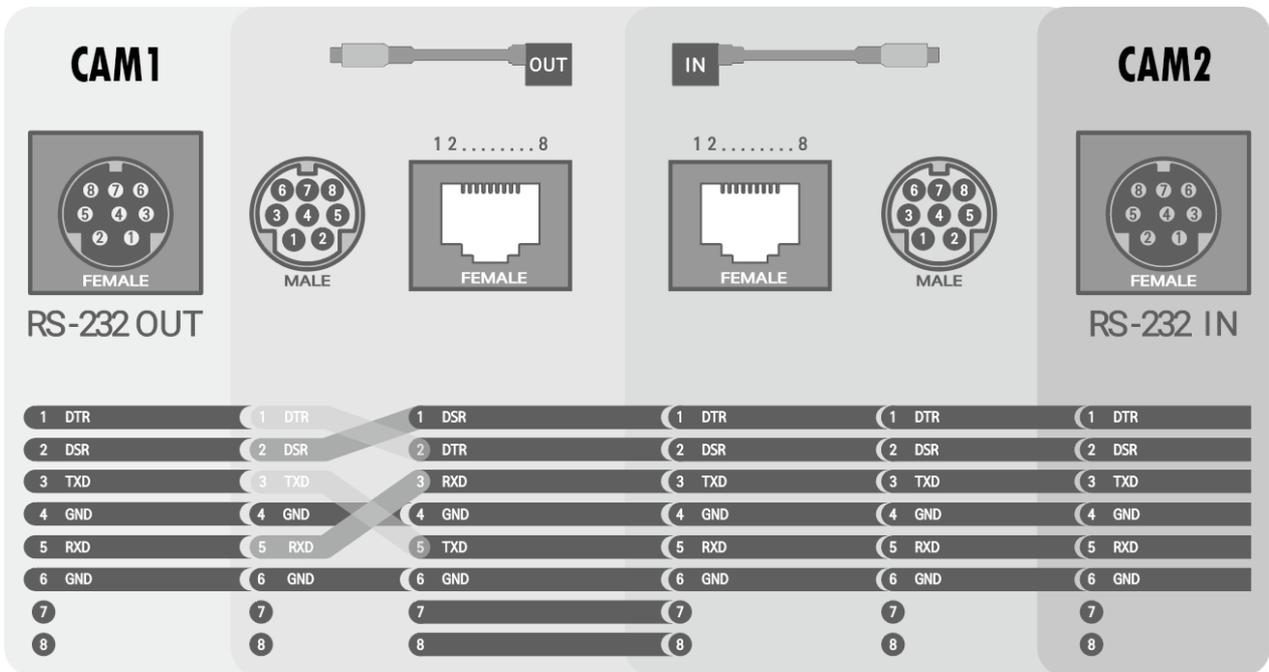

* Connect the 232 IN / 232 OUT cable using the direct LAN cable.

- N:N camera connection using RJ-45 LAN (RS-422)

- Camera connection is possible with only LAN cable.

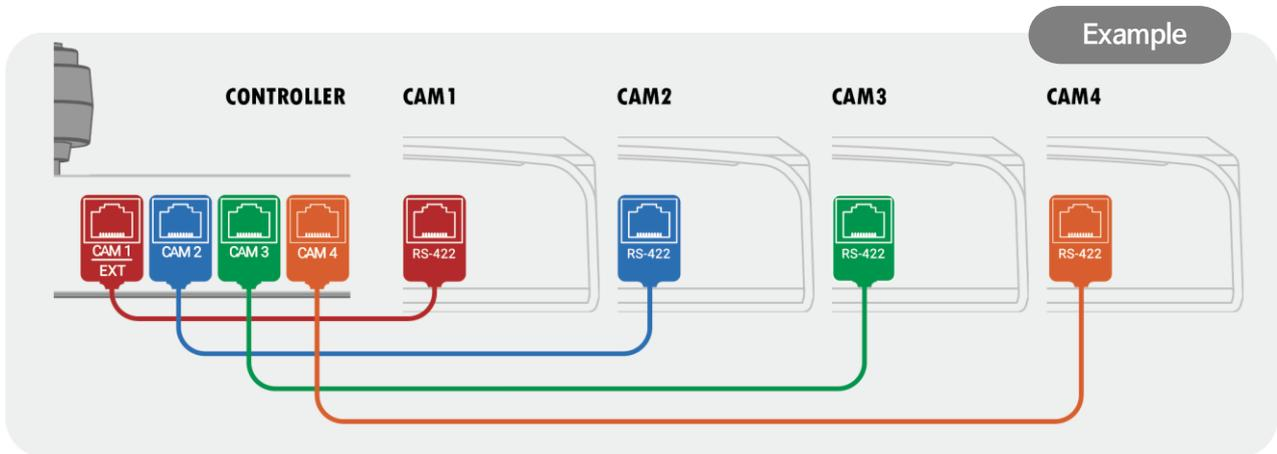
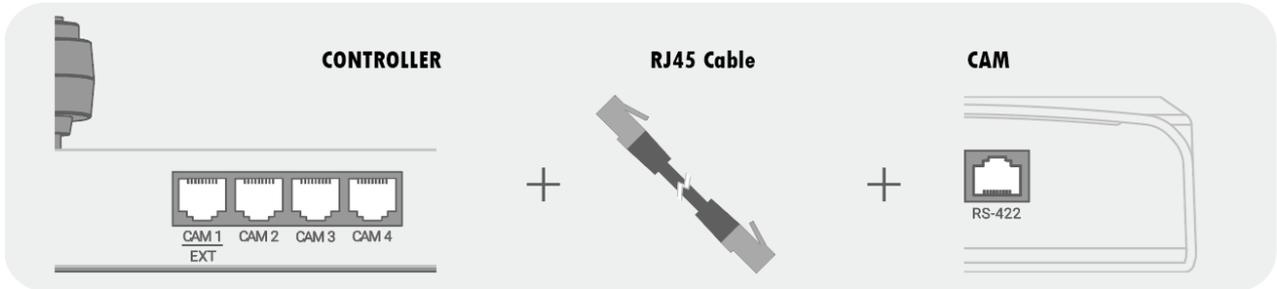

- Refer to the figure below for the LAN cable wiring between the controller and cameras.

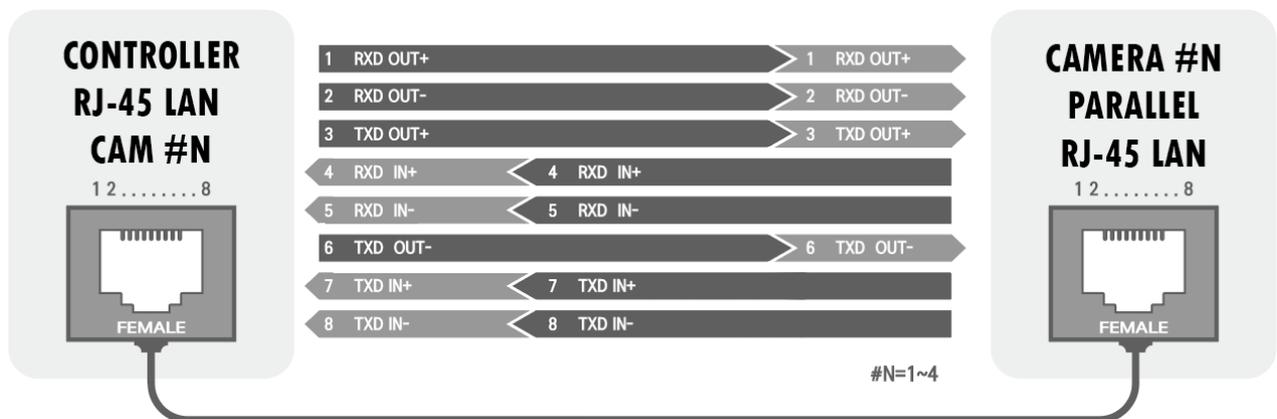

- 1:N camera connection using RJ-45 LAN (RS-422)

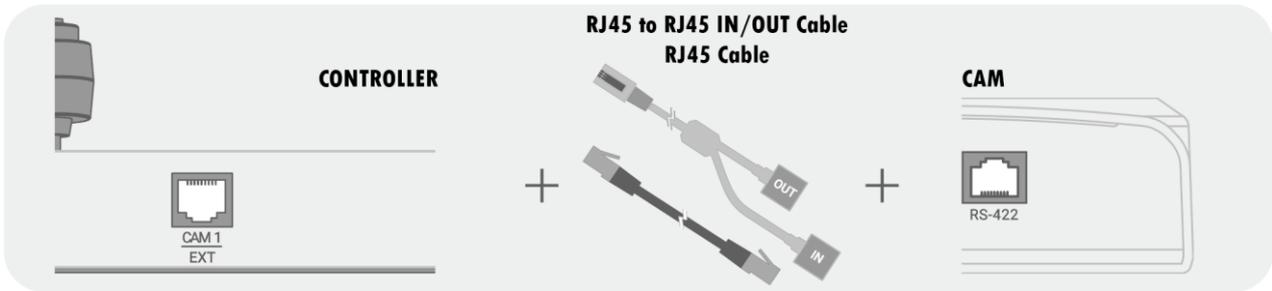

Example

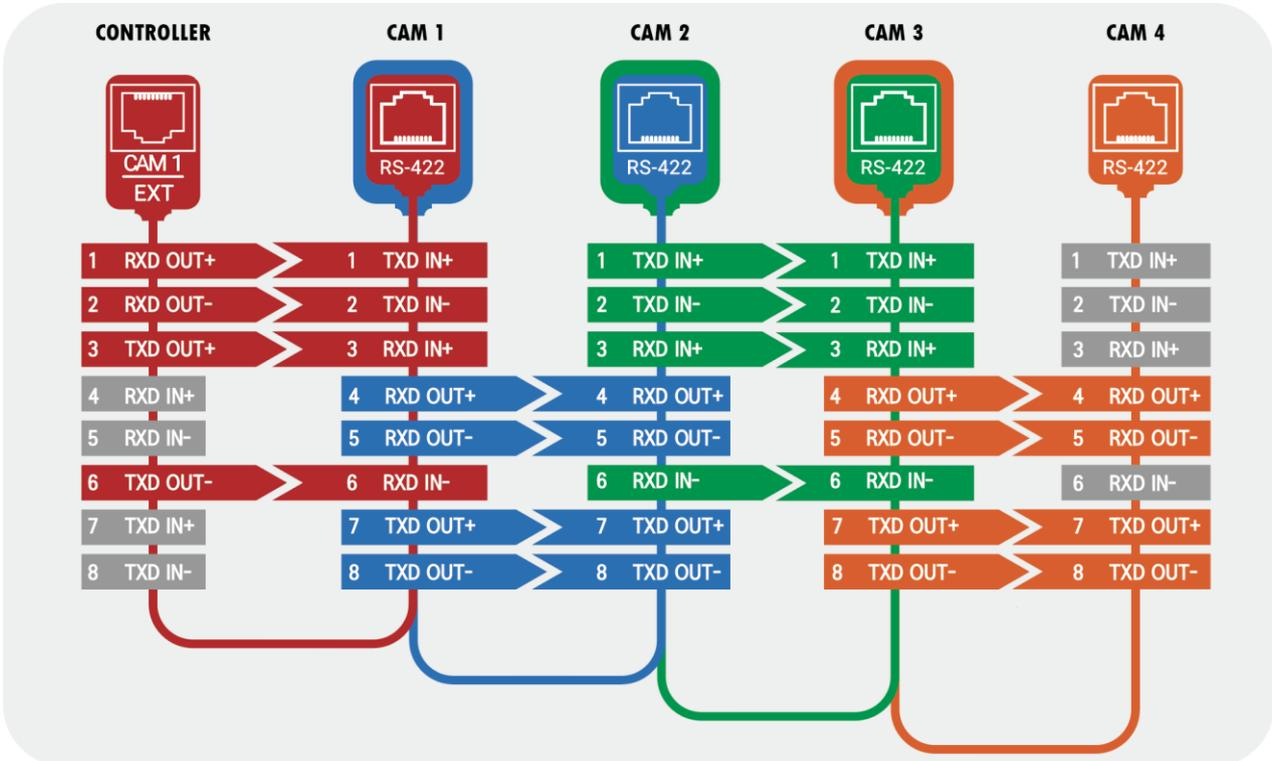
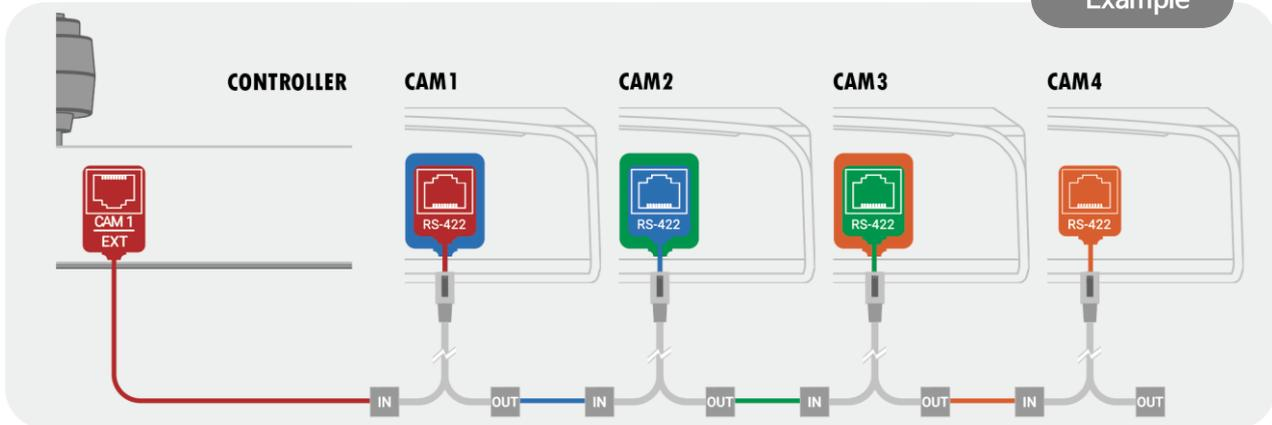

● You can conveniently connect the camera with only a LAN cable using the RJ-45 to RJ-45 IN/OUT cable included with the Package.

⑥ Installation Check

- Before supplying power, make sure that there is no abnormality in wiring.
- Check the camera ID you want to adjust and then select the correct camera ID on the controller.
You can check the camera ID on the screen or ID setting switch.
- If the controller supports multiple protocols, match them with the protocol set in the camera.
- Make sure to change the camera protocol and video output format while the power is off.
 - Please refer to how to use the controller if the function related to the controller can't be operated normally because the method of using it may be different depending on the controller. This manual is based on PELCO and VISCA standard protocol controller.

⑦ Power

The rated power of this product is DC 12V/1A. Please check whether the power to use is DC 12V output and the capacity is more than 1A.

Rated Power	Input Voltage Range	Current Consumption
DC 12V	DC 12V \pm 10%	Current Max 1.5A



- ◆ In case of DC power supply, if the power is applied in the wrong polarity, the product may be damaged.
Pay particular attention to the polarity of the power supply.
- ◆ If DC power connection is too long, the product may not operate due to voltage dip. Therefore, wire the DC power supply wiring as short as possible.
- ◆ We are not responsible for any damage to the equipment caused by improper power connection.

Main Features

Screen Menu

While viewing the menu displayed on the connected monitor, you can change various status settings such as camera shooting conditions, system settings, information, and functions.

	IR Remote	C-K100	C-K200
GO to MENU or EXIT	DATA SCREEN	 	 
Save	HOME/SET	Top button of the Joystick	Joystick Button or 
Cancel	BACK		

* When using PELCO-D/P protocol, you can enter Preset 95, too.

PRESET

Preset is a function that saves and recalls the video status, white balance, and exposure adjusted by pan / tilt and zoom / focus.

Number of assignable presets depends on its protocol.

VISCA	Preset 255
PELCO D/P	Preset 255

When using VISCA protocol, pattern, swing, group will be carried out in each range from 1 to 8.
When using PELCO D/P protocol, preset will be carried out in its range from 131 to 160 and 95.

- Preset 95 allows you to enter MENU.
- Preset 131~138 perform pattern 1~8.
- Preset 141~148 perform swing 1~8.
- Preset 151~158 perform group 1~8.

*Preset setup range may vary depends on the controller.
Ex.) C-K200/K100 can set up to 255 Presets.

You can set the label separately for each preset. The label is automatically set to Blank when you directly specify the preset position using the IR remote and the controller. If you want to change each setting value, please use the menu.

You can also set, run and delete the preset positions from within the menu.

- Interlocking operation with the camera controller(based on C-K200)

Set Preset	IR Remote: Preset button → Press and hold the SET button + Preset No. Button Controller: Press and hold the PRESET button + Preset No. Button
Run Preset	IR Remote: Preset button → Preset No. Button Controller: PRESET button lights up → Number pad
Delete Preset	IR Remote: Use the OSD menu Controller: PRESET button lights up → Press and hold the RESET button + Preset No. Button

SWING

Swing function allows you to make camera move between 2 preset positions repeatedly.

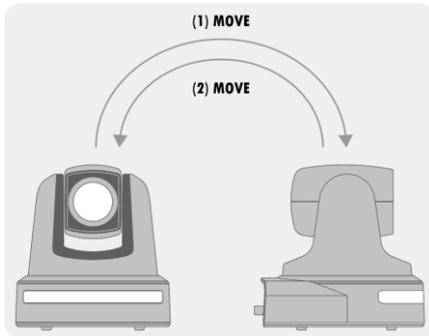

When swing function activates, the camera moves from the first preset to the second preset position, and then from the second preset position to the first preset position.

If you push other buttons or move joystick, swing will stop running. The operating speed can be set from 1 °/sec to 180 °/sec.

Set swing	IR remote: SWING button → Press and hold the SET button + Swing no. button Controller: SWING button + Swing no. button
Run swing	IR remote: SWING button + Swing no. button Controller: SWING button lights up → Number pad
Delete swing	IR remote: Use the OSD menu. Controller: SWING button lights up → Press and hold the SET button + Swing no. button

PATTERN

Pattern operation is a function that saves Pan, Tilt, and Zoom operations performed for a certain period of time and executes them again.

If you push other buttons or move joystick, Pattern function will be inactivated.

Up to 8 patterns can be recorded, and Max. 1200 actions can be stored per pattern.

Set pattern	IR remote: PATTERN button → Press and hold the SET button + Pattern no. button Controller: Press and hold the PATTERN button + Pattern no. button
Set Preset	IR Remote: Preset button → Press and hold the SET button + Preset No. Button Controller: Press and hold the PRESET button + Preset No. Button
Run Preset	IR Remote: Preset button → Preset No. Button Controller: PRESET button lights up → Number pad

GROUP

Group function is a function that repeatedly activates preset combinations of the preset, swing, and pattern functions.

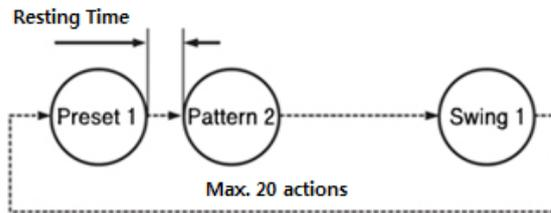

Max. eight groups can be assigned, and each group can set up to 20 actions (presets, swings, patterns). The presets set in the group can specify the operation speed, and pattern and swing can specify the number of repetitions. You can also set the resting time for stopping operation after each action.

Set group	IR remote: GROUP button → Press and hold the SET button + Group no. button Controller: Press and hold the GROUP button + Group no. button
Run group	IR remote: GROUP button → Group no. button Controller: GROUP button lights up → Number pad
Delete Group	IR remote: Use the OSD menu. Controller: GROUP button lights up → Press and hold the GROUP button + Group no. button

Other Functions

Power Up Action	This function enables to resume the last action executed before power down. Only Preset, Swing, Pattern, Group, and Preset1 actions are performed again and PTZ adjustment is excluded from this function.
Smart Flip	If the tilt angle exceeds 90°, this function will automatically flip the image. If Smart Flip is activated, the screen displays the letter F . If the tilt angle exceeds 90°, this function will automatically flip the image. If Smart Flip is activated, the screen displays the letter F. When this function is turned OFF, the operation range of Tilt is changed as below. Smart Flip Off: -20° ~ 90° / Smart Flip On: -20° ~ 200°.
Parking Action	If the camera is not operated for a certain period of time, it automatically moves to the preset position. "Wait Time" can be set to a value from 1 minute to 4 hours.

Menu Function

OSD (On Screen Display) Configuration

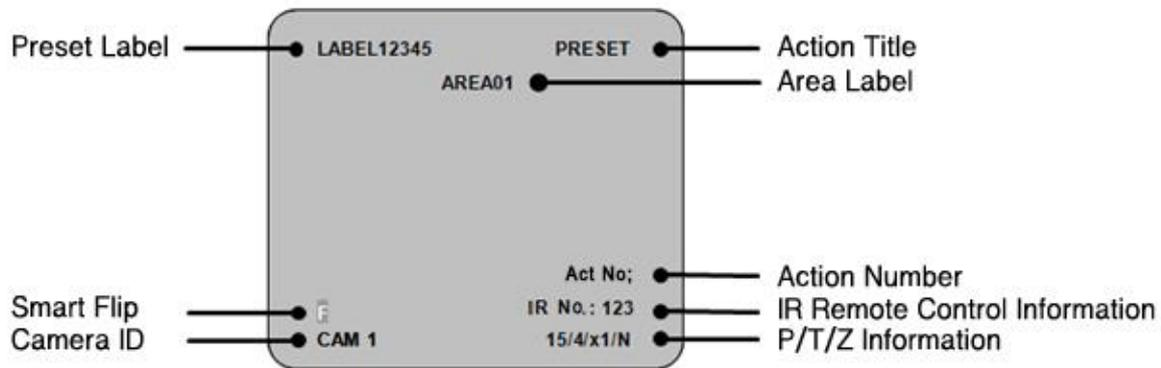

Preset Label	Displays preset name during preset operation.
Smart Flip	Displays the image flip status by Smart Flip function.
Camera ID	Displays the current Camera ID.
Action Title	The following information is displayed in the Action Title. - Set Preset xxx: When setting the preset position - Preset xxx: When moving to the preset position - Swing x/Preset xxx: Displays swing number and preset number when Swing is activated - Undefined: When an undefined action is selected
Area Label	Displays the label of the area.
Action No;	Displays the Action number value. /Displays the Undefined number value.
IR Remote Control Information	Displays the IR remote numeric input value.
P/T/Z Information	Displays the current Pan/Tilt/Zoom/compass direction.

Main Menu

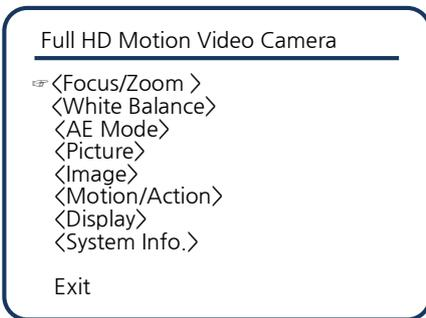

Focus/Zoom : Controls focus and zoom

White Balance : Sets the White Balance.

AE Mode : Sets exposure value by selecting brightness, aperture, and shutter speed.

Picture : Sets detailed value of exposure of the camera.

Image : Sets screen setting value.

Motion/Action : Sets movement such as preset swing, pattern and group.

Display : Sets whether to display the main screen OSD on each item.

System Info. : Displays the information and setting status of the product and initializes the data.

1 Focus/Zoom

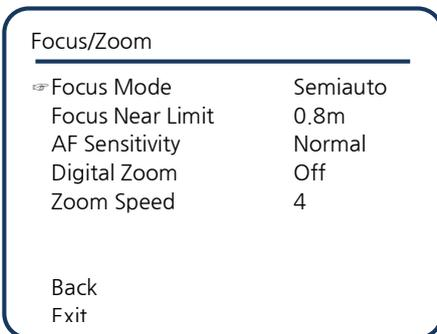

Focus Mode : Sets the focus mode of the camera. Semiauto mode is manually operated only when preset operation is activated, and Auto focus mode is automatically switched when PTZ is adjusted.

[Semiauto/ Auto/ Manual]

Focus Near Limit : Adjusts minimum focus distance when camera walking.

[1cm/ 11cm/ 30cm/ **0.8m**/ 1.2m/ 1.4m/ 1.65m/ 2.0m/ 2.5m/ 3.1m/ 4.2m/ 6m/ 10m/ 20m/ Over Inf]

AF Sensitivity : Used to adjust the focus at the fastest speed. Generally, the Normal mode is used when shooting frequently moving objects. In Low mode, the focus stability is improved. It is stable even if the brightness of the light is low or the brightness is changing. [Normal/ Low]

Digital Zoom : Used to activate/deactivate the digital zoom function. .[On/ Off]

Max. x240 is available for the SHARON 20 And Max. x360 is available for the SHARON 30

Zoom Speed : Sets the zoom In/Out speed. (Applicable when using IR remote) [0~7, default: 4]

② White Balance

Calibrates the colors for better reproduction based on the exact white color under the various light sources.

White Balance	
Mode	Auto
Red Gain	211
Blue Gain	156
Back	
Exit	

Mode : Auto and ATW are set automatically, and Sodium is set based on sodium, etc. In Manual mode, the camera chromaticity (Red / Blue Gain) is set manually.

[Auto 2500-7500K/ Indoor 3200K/ Outdoor 5800K/ One Push/ ATW 2000-10000K/ Manual/ Outdoor Auto/ Sodium Auto/ Sodium/ Sodium Out Auto]

※ The following is activated only when the Mode is set to Manual.

Red Gain : Adjust Red value. [0~255, default 211]

Blue Gain : Adjust Blue value. [0~255, default 156]

③ Auto Exposure

Sets the mode related to the exposure of the camera.

AE Mode	
Mode	Full Auto
Gain Limit	43.1dB
Exp Comp	Off
Shutter Speed	1/60
Iris Level	F1.6
Gain Level	9.2dB
Bright Level	16
Back	
Exit	

AE Mode : Sets the exposure by adjusting the aperture and shutter speed.

Full Auto automatically sets the aperture and shutter speed. Iris Pri sets the aperture manually, and Shutter Pri sets the shutter speed manually.

[Full Auto/ Bright/ Shutter Pri/ Iris Pri/ Manual]

Gain Limit : Sets the maximum Gain level.

[9.2dB~43.1dB, default 18.5dB]

Exp Comp (Exposure Compensation): Sets the maximum brightness. [Off, -10.5dB~0dB~10.5dB]

Shutter Speed : Adjusts the shutter speed. [1/1~1/10000, default 1/60]

※ Only activates when the AE Mode is set to Shutter Pri.

Iris Level : Adjusts the aperture. [F1.6~F14, CLOSE]

※ Only activates when the AE Mode is set to Iris Pri.

Gain Level : Adjusts the Gain level. If the value is higher than the Gain Limit, the actual setting value is set to the value of the Gain Limit. [0dB~43.1dB]

Bright Level : Set using pre-set Gain and Iris. [0~27, default 14]

4 Picture

Configures general settings of the camera's exposure.

Picture	
☰ Slow Shutter	Off
BLC	Off
WDR	Off
HR Mode	On
Image Stabilizer	Off
Day/Night	Day
└─Threshold Level	0
Back	
Exit	

Slow Shutter : Set ON to set Slow Shutter automatically in dark environment. It operates when AE Mode is Full Auto. [On/ Off]

BLC: Used to set the BLC(Back Light Compensation) function to make the subject and background clear at the same time when the shooting environment is in strong backlight. [On/ Off]

WDR : Used to set the WDR(Wide Dynamic Range), a backlight correction function. [On/ Off/ VE]

* The WDR function is applied to PRC-KA30 and PRC-KA30S only.

HR Mode (High Resolution) : Used to improve the outline details to provide better images. [On/ Off]

Image Stabilizer : Used to correct the image jitter.

※ When using the Stabilizer function, the viewing angle will decrease.

* Only works when vibrating level is under 10Hz. [On/ Off]

Day/Night : Used to set the use of IR cut filter (Infrared cut filter) to absorb more light at night.

[Day/ Night/ Auto]

Threshold Level : In Day/Night Auto mode, you can set the threshold value that changes from Night to Day in IR cut filter. [0~28]

5 Image

Image

Image Flip	Off
Defog Mode	Off
Picture Effect	Off
High Sensitivity	Off
Noise Reduction	3
Gamma	Standard
Aperture	10
Freeze in Preset	Off
Back	
Exit	

Image Flip : Flips the current image up, down, left, and right. Set the Image Flip to Off when using in forward direction, and On when using in reverse direction. [On/ Off]

Defog Mode : Use when exposed to fog or smoke . [Off/ Low/ Mid/ High]

Picture Effect : When setting Neg.Art, Negative and Positive are reversed. The B/W is a black and white image. [Off/ Neg.Art/ B/W]

High Sensitivity : In a dark environment, the value of Gain is set to the maximum value to make the picture brighter.

※ If the value of Gain reaches the maximum level, noise may appear in the picture. [On/ Off]

Noise Reduction : Removes noise in the image. [Off/ 1~5, default 3]

Gamma : Sets the Gamma. [Standard/ Straight]

Aperture : Adjusts the sharpness of the image. [0~15, default 10]

Freeze in Preset : During preset operation, used to stop the image before movement and restores the image after movement. [On/ Off]

6 Motion/Action

Motion/Action

<Motion>
<Preset>
<Swing>
<Pattern>
<Group>
<Parking Action>

Back
Exit

Motion : Sets the general motion operation settings.

Preset : Sets the general preset operation settings.

Swing : Sets the general operation settings of the Swing.

Pattern : Sets the general operation settings of the Pattern.

Group : Sets the general operation settings of the Group.

Parking Action : Sets the Parking Action.

Motion

Sets the general motion operation settings.

Motion	
⇒ Action Lock	Off
Power Up Action	On
Smart Flip	On
PT Direction	Normal
Preset Speed	300/sec
<PT SPEED>	
<Home Position>	
<North Direction>	
Back	
Exit	

Action Lock : When the Action Lock is set to On, functions such as preset, swing, and group cannot be deleted or set as new in normal operation, but can only be executed. [Off /On]

※ This locking does not apply within the OSD menu.

Power Up Action : When power is supplied to the camera, it performs the action that was performed before power off. Only the Preset_Recall, Swing, Group, and Preset1 actions are resumed, and PTZ action is excluded from this function. [On/ Off /Preset1]

Smart Flip : If tilt angle exceeds 90°, this function will rotate the image automatically. When image rotation is activated, the letter **F** is displayed on the screen. When this function is turned off, the operating range of the tilt is as follows.

Image Flip Off: -20°~90°, Image Flip On: -20°~180°~-160° [On/ Off]

PT Direction : In Normal mode, the operation direction and the screen movement become the same, and if it is set to Inverse, the operation direction and the screen movement direction are reversed. [Normal/ Inverse]

Preset Speed: Used to set the preset speed.[5°/sec~300°/sec]

PT SPEED : Used to set PT Max Speed, PT With Zoom and Acceleration functions.

Home Position : Used to select the position of Home. [Set position with PT. Default is Center.]

North Direction : Used to designate the North direction. [Set position with PT. Default is Center.]

PT Speed Setup

Sets the operation speed related to Jog, Preset and Home position movement.

PT Speed	
PT Max Speed	60/sec
PT with Zoom	On
Acceleration	High
Back	
Exit	

PT Max Speed : Used to set the maximum operation speed. The operation speed is linked to the zoom magnification(PT with Zoom ON), so the larger the zoom magnification, the slower the speed. It is the same effect as the speed variable in the regulator, so you can use this function if you want fixed low speed or high speed. [5°/sec~60°/sec~180°/sec]

PT with Zoom : The operating speed varies depending on the zoom magnification. [On/ Off]

Acceleration : When moving the position such as Preset, Home, Swing, Pattern except Jog, it stops by applying variable speed instead of constant speed in stopping operation of the selected position to produce more natural motion. [High/ Middle/ Low]

Home Position Setup

Home Position	
┌	┐
└	┘
Move to Home Position	
[SET:Save /BACK:Cancel]	

To set the Home position, move to desired Pan / Tilt, Zoom position and press the SET button or the button on the Joystick to save.

North Direction Setup

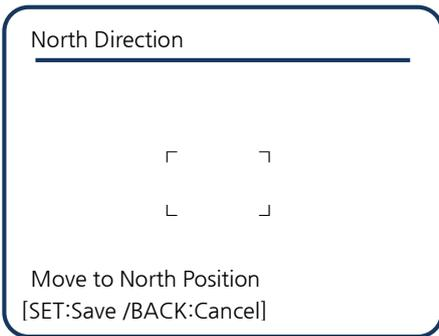

To set the North direction, move to desired Pan position and press the SET button or the button on the Joystick to save.

Preset Setting

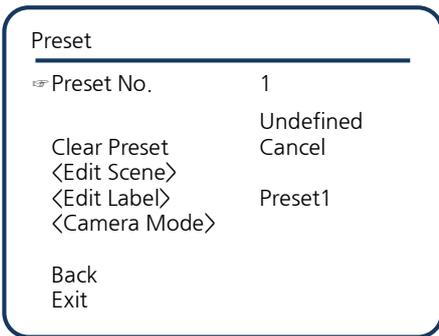

Preset No. : Select the preset number you want to set. If you select a predefined preset number, preset move is performed and the set label is displayed. If the selected preset is not defined, "Undefined" is displayed below the preset number. [1~255]
 ※ When using PELCP D/P protocol, 95 and 131~160 are excluded.

Clear Preset : Deletes all the settings of the current preset. [Cancel/ Ok]

Edit Scene : Designates the preset position in the submenu.

Edit Label : Used to set the preset label using this submenu, which will be displayed on the screen while the camera remains within the range defined by the preset. Up to 10 letters can be entered for a label.

Camera Mode : Used to change the image settings of the camera in the submenu.

Edit Scene- Preset Setup

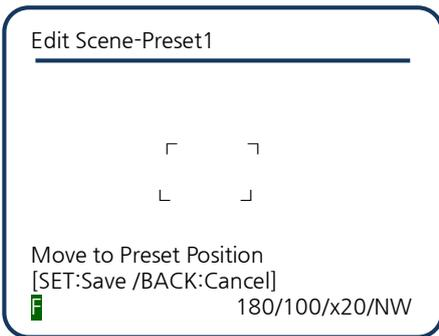

Use the IR remote or controller to move the camera to the desired position to create the desired angle of view.

Press the SET button or the button on the top of Joystick to store the preset position.

Press BACK key to cancel the changes.

Edit Label-Preset Setup



The highlighted portion of the label is the current cursor position, and the character moves to the right.

Select the letter specified in the Character Map section at the bottom of the label.

Move the cursor to the desired character position by using the IR remote or the controller and press the SET or joystick button to select the character.

Select " " when setting to blank, "←" to delete the current character and move the position to the left.

When the label setting is completed, move the cursor to the "Ok" position and press SET or the joystick button to save. Select "Cancel" to cancel saving.

Swing Setup

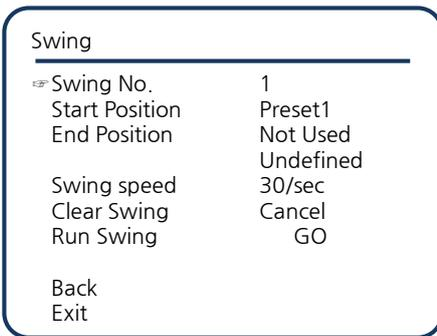

Swing No. : Select the swing number to be set. If the selected swing number is not set, Start Used and End Position are displayed as "Not Used". [1~8]

Start Position / End Position : Set two positions for swing operation. "Undefined" is displayed when a preset number that is not set is selected.

Swing operation moves clockwise from Start Position to End Position and then moves counterclockwise from End Position to

Start Position. However, the two positions are not set to the same preset. PELCO-D/P[Refer to Page23] / VISCA[Swing 1~8]

Swing Speed : Used to set the swing speed. [1°/sec~180°/sec]

Clear Swing : Used to delete the current setting. [Cancel / Ok]

Run Swing : Used to activate or preview the currently set swing. Select Go to exit the menu and activate the set swing. When Preview is selected, the preview of the set swing is displayed in the submenu [Go/ Preview]

Pattern Setup

Pattern	
⇒ Pattern No.	1 Undefined
Clear Pattern <Edit Pattern>	Cancel
Run Pattern	Go
Back Exit	

Pattern No. : Used to select the pattern number to be set. If the selected pattern is not defined, "Undefined" is displayed below the pattern number. [1~8]

Clear Pattern : Used to delete the current pattern setting. [Cancel/ Ok]

Edit Pattern : Used to start modifying the pattern in the submenu.

Run Pattern : Used to activate or preview the currently set pattern. Select Go to exit the menu and activate the set pattern. When

Preview is selected, the preview of the set pattern is displayed in the submenu.

[Go/ <Preview>]

Group Setup

Group	
⇒ Group No.	1 Undefined
Clear Group <Edit Group>	Cancel
Run Group	Go
Back Exit	

Group No. : Used to select the group number to set. If the selected group is not defined, "Undefined" is displayed below the group number. [1~8]

Clear Group : Used to delete the current group setting. [Cancel/ Ok]

Edit Group : Used to start modifying the group in the submenu.

Run Group : Used to activate or preview the currently set group. Select Go to exit the menu and activate the set group. When

Preview is selected, the preview of the set group is displayed in the sub menu.

[Go/ <Preview>]

Edit Group-Group Setup

Edit Group1	
No Action ### Dwell OPT	
1	None
2	None
3	None
4	None
5	None
Save [←→:Move Cursor]	
Cancel [↑↓:Change Value]	

Action ### [None/Preset/Swing] : Select the pattern number to set. If the selected pattern is not defined, "Undefined" is displayed below the pattern number. [1~8]

Dwell [0 sec~4 min]: Used to set the delay after completion of the action.

OPT : Sets the preset moving speed for preset actions or the number of repetitions for swing actions.

Edit Group1	
No Action ### Dwell OPT	
1	None
2	None
3	None
4	None
5	None
Save [SET: Edit]	
Cancel	



Edit Group1	
No Action ### Dwell OPT	
1	None
2	None
3	None
4	None
5	None
Save [SET: Edit Action]	
Cancel [BACK:Edit End]	

Edit Group1	
No Action ### Dwell OPT	
1	Preset 1 00:03 360
2	None
3	None
4	None
5	None
Save [←→:Move Cursor]	
Cancel [↑↓:Change Value]	



Edit Group1	
No Action ### Dwell OPT	
1	Preset 1 00:03 360
2	None
3	None
4	None
5	None
Save	
Cancel	

1. Press the SET or joystick top button in the "No" item to start group setup.
2. You can set 20 items in 1 group. Use UP/DOWN to move to the desired item number and press the SET or the ENTER button on the joystick to edit the item.
3. Set item type, delay time, and Option value. Selected items are highlighted. Use LEFT/RIGHT to move the cursor between items, and use UP/DOWN to change the setting value in each item.
4. Enter the setting value while moving each item.
5. After finishing the setting for the desired item, press the SET or joystick button/ENTER button to return to the previous step. Use the UP/DOWN keys to move to another item number and set.

After completing the setting for all items, press the BACK key to move the cursor to 'SAVE' item. Press the SET or joystick button/ENTER button to save the setting.

Parking Action Setup

This function automatically executes the specified operation when the camera is not operated during the set "Wait Time".

Parking Action	
☞ Park Enable	Off
Wait Time	00:10:00
Park Action	Home
Back	
Exit	

Park Enable : Used to set the activation of the Parking Action function. [On/Off]

Wait Time : It is displayed as "hour: minute: second" and can be set in minutes or more. [1min.~4 hours, default **10min.**].

Park Action : When set to Home, it moves to the initial position. [Home/ Preset/ Swing/ Group]

7 Display Setup

Sets whether to display the main screen for each item.(Refer to Page22.)
When set to Auto, it is displayed only when each information is changed.

Display	
Display All	No
└Camera ID	Off
└PTZ Information	Auto
└Flip Status	Auto
└Action Title	Auto
└Preset Label	Auto
└IR Info.	Off
<Area Label>	
☞ Back	
Exit	

Display All : Used to display all items. [Auto/ On/ Off]

Camera ID : Used to display the camera ID. [On/ Off]

PTZ Information : Displays the current Pan/ Tilt/ Zoom/ Compass direction. [On/ Off/ **Auto**]

Flip Status : Displays the top, bottom, left, and right reversal status of the image. [On/ Off/ **Auto**]

Action Title : Displays the current preset, swing, pattern, and group information. [On/ Off/ **Auto**/ Semiauto]

Preset Label : Displays the predefined preset label. Displays the current preset, swing, and group information. [On/ Off/ **Auto**]

IR Info. : Used to set whether to display the number pad key on the IR remote. [On/ Off]

Area Label : Sets the section and the LABEL for that section. [On/ Off/ **Auto**]

Area Label Setup

It is a function that sets a specific area and its label to display the label on the main screen when the camera is move to the corresponding area.

Area Label

☞ Display Off
Clear Area Label Cancel
<Edit Scene>
<Edit Label>

Back
Exit

Display : Displays the set Area Label. If set to Auto, it is displayed during operation. [On/ Off/ **Auto**]

Clear Area Label : Used to delete all areas and label settings of the currently set Area Label. [Cancel/ Ok]

Edit Scene : Used to change the area of the Area Label in the submenu.

Edit Label : Used to edit the label of the Area Label in the submenu.

※ If no area is defined, <Edit Label> menu is disabled.

※ The area setting can be set by moving to the right direction.
Image Flip is automatically set to Off when area setting and it returns to the previous setting once the setup is completed.

Edit Scene

Edit Scene-Area Label



Pan to Start of Area Label **01**
[SET:Set /BACK:Back]
180/100/x20/NW

You can pan the camera **only in a clockwise direction**. When setting the setting area, Image Flip is automatically set to Off. After completing the setting, Image Flip will return to the original setting value. Up to 16 areas can be set.

Move to **the beginning point** of the first area and press the SET or the joystick top button/ENTER button to save.

Edit Scene-Area Label



Pan Right Only
Pan to End of Area Label **01**
[SET:Set /BACK:Back]
180/50/x20/NW

Move to the **ending point** of the first area and press the SET or the joystick top button/ENTER button to save. After the setting is completed, press the FAR or BACK key to exit area setup.

After completing the area setting, press the FAR or BACK key to return to the Area Label setting screen.

Edit Scene-Area Label

Area Saved Successfully

[BACK:Set Continue]

After completing the area setting, press the BACK button to return to the Area Label setting screen.

Edit Scene-Area Label

Error Programming Areas
Last Pan was Pan Left

[BACK:Set Continue]
180/50/x20/NW

An error message will be displayed if the left side is selected during the are setup. Press the BACK key to return to the Area Label setting screen and reset.

Edit Label

```
Edit Label-Area Label
-----
Area Label No.      1
                    Undefined
<Edit Area Label>  AREA 01

Back
Exit
```

Area Label No.[1~16] : Select the area number to be set.

If the selected area is not yet defined, Undefined displays under the area number.

Edit Area Label : Used to set the area label in the sub menu.

Max. 10 letters can be entered.

Area Label Setup

```
Edit Area Label01
-----
[A]REA 01 ]
-----
1234567890      Ok
[A]BCDEFGHIJ    Cancel
KLMNOPQRST
UVWXYZabcd
Efg hijklmn
Opqrstuvw x
yz<>-. ←
-----
```

The highlighted portion of the label is the current cursor position, and entering a letter moves the cursor to the right.

Select desired letter specified in Character Map section at the bottom of LABEL. Use LEFT/RIGHT/UP/DOWN of the IR remote or controller to move the cursor and press the SET or joystick top button/ENTER button to select the corresponding letter.

Select Space(" ") when setting to blank, Backspace("←") to delete the current letter and move to the previous letter.

When the label setting is completed, move the cursor to the "Ok" position and press the NEAR or the joystick button to save. Select "Cancel" to cancel saving.

8 System Info.

System Info.	
Camera Model	: PRC-KA30S
CAM F/W ver.	: 0.02Sxx
System Select	: 1080p60
Protocol	: VISCA
Baudrate	: 9600bps
Camera ID	: 1
IR-Receive	: On
⇒ <Additional Info.>	
Back	
Exit	

Camera Model : Displays the model name of the camera.

CAM F/W ver. : Displays the S/W version of the camera.

System Select : Displays the set Video Format.

※ Check the output video format setting section.

Protocol : Displays the selected protocol.

※ Check the communication protocol setting section.

Baudrate : Displays the selected Baudrate of the set protocol.

※ Check the communication protocol setting section.

Camera ID : Displays the selected Camera ID.

※ Check the camera ID setting section.

IR-Receive : Used to decide whether to operate the camera with the IR remote. [On/ Off]

※ It is used when the camera malfunctions due to lighting equipment around the camera.

Only the wired IR remote can change the menu.

Additional Info : Displays the camera type, version, and pan motion information in the submenu and performs system initialization.

Additional Info.

Additional Information	
Camera Type	: S30
Camera ver.	: 0400
Pan Rotation	: 2
<System Initialize>	
⇒ Back	
Exit	

Camera Type : Displays the camera's zoom type.

Camera ver. : Displays the camera's zoom version.

Pan Rotation : Displays the number of Pan rotations.

System Initialize : Used to initialize the settings to the factory default or reboot the system.

System Initialize

System Initialize	
Factory Default	NO
-Display Control	NO
-Camera Mode	NO
-Motion	NO
-Action	NO
Restart Zoom	NO
Restart System	NO
Back	
Exit	

Factory Default : Initializes the Display setting value, camera setting value, motion setting value, and user edit data.

Display Control : Initializes the Display setting value.

Camera Mode : Initializes the White and AE function.

Motion : Initializes the Motion setting value.

Action : Deletes the Preset, Swing, Group data.

Restart Zoom : Reboots the Zoom camera.

Restart System : Reboots the product.

IR Remote Control

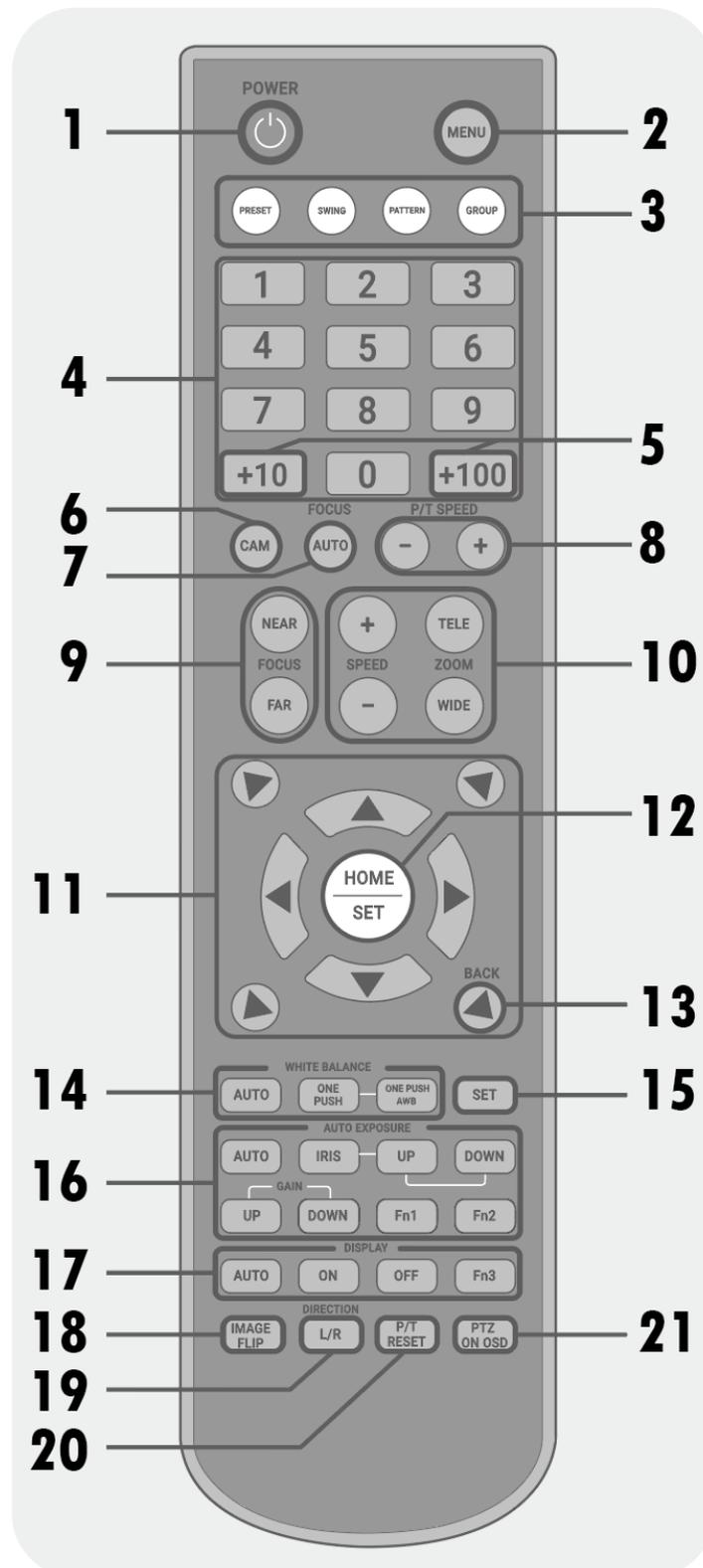

1. **POWER** : Turn On/ Off the camera

2. **MENU** : Enter menu or exit menu.

3. **PRESET/SWING/PATTERN/GROUP** : Select to operate, set, or save.

4. Number pad (0~9)

- Used to set the camera ID to be controlled with the CAM button.
- Used to select a number for operating, setting, saving the selected preset, swing, pattern, group.
- Only when PRESET is selected, the range(BANK) of PRESET is selected with the +10 or +100 buttons.

5. +10/ +100 (BANK)

- Used to set and operate preset function in 10 units using 0 ~ 9 number keypad.
- For example, if you frequently use presets from 120 to 129, set the BANK to 120 and use the number keypad 0 ~ 9 to move the preset position between 120 and 129.

◆ BANK Setup

1) Set range between 1~9

- Ⓐ Press +10 or +100 button
- Ⓑ Press 0 button on the number keypad

2) Set range between 10~99

- Ⓐ Press +10 button
- Ⓑ Select a desired 10's digit number.

ex) Set range between 30~39: +10 → 3

3) Set range between 100~255

- Ⓐ Press +100 button
- Ⓑ Select a desired 100's digit number(1,2) and 10's digit number in order.

ex) Set range between 100~109: +100 → 1 → 0

ex) Set range between 130~139: +100 → 1 → 3

6. **CAM** : Sets the camera ID to be controlled.

◆ Camera ID Setup

- Ⓐ Press the CAM button for about 3 seconds.
- Ⓑ Check that the LED of the PRESET button blinks for about 2 seconds and then **lights up**.
- Ⓒ Select the ID number of the camera to be controlled.
- Ⓓ Press the CAM button again.
- Ⓔ Check that the LED of the PRESET button blinks and then **lights down**.

7. FOCUS AUTO : Sets Auto focus.

8. P/T SPEED : Changes the camera's up/down/left/right movement speed.

The speed can be adjusted from 5° /sec to 360°.

9. FOCUS : It is set manually. Use the NEAR or FAR button to adjust the focus.

10. SPEED/ ZOOM : Use the TELE or WIDE button to adjust the zoom magnification.

Use + or - to change the zoom speed.

11. Up/Down/Left/Right / Diagonal: Use the arrow buttons to move pan tilt or cursor of the MENU.

12. HOME/ SET : The HOME button moves the pan tilt position to the set HOME. When entering the menu, the SET button is used to set the changed values in the menu.

13. BACK : It is used to enter the upper menu after entering the menu.

14. WHITE BALANCE : White Balance Changes to AUTO or ONE PUSH mode.

15. SET : Used to set the selected preset, swing, pattern and group.

◆ Preset, Swing, Pattern, Group Setup

ⓐ Press and hold the SET button and press the number for the setting.

16. AUTO EXPOSURE : Changes the Auto Exposure to AUTO or IRIS mode.

17. DISPLAY : Sets the main screen OSD to AUTO, ON or OFF.

18. IMAGE FLIP : Flips the current image up, down, left, and right.

19. DIRECTION L/R : Reverses the left/right direction of camera operation.

20. P/T RESET : Used to initialize the Pan and Tilt of the camera.

Used when the direction of camera is changed due to external shock.

NDI Finder application

BASIC

NDI finder apps can be downloaded by visiting the download center of Salrayworks' homepage as below.

<http://salrayworks.com/index.php/download-center/>.



Both the Window version and the MAC version are valid.

The logo for Salrayworks, featuring the word "SALRAYWORKS" in a bold, sans-serif font. The "S" and "A" are red, while the rest of the letters are black.

NDI FINDER for MAC	
File Size	72.49
Downloads	13
downloads : 다운로드하다	
SW UTILITY	
NDI FINDER for Window PC	
File Size	51.27
Downloads	10
SW UTILITY	

After installation, the NDI Finder icon appears on the desktop.



Clicking the NDI ICON runs NDI finder apps as below

The main purpose of NDI finder is to automatically search and acquire SHARON's NDI Devices' full IP information in the local network. And if you lose the login password of each web server of SHARON NDI devices, you could initialize for reset Password, if you forgot PW.

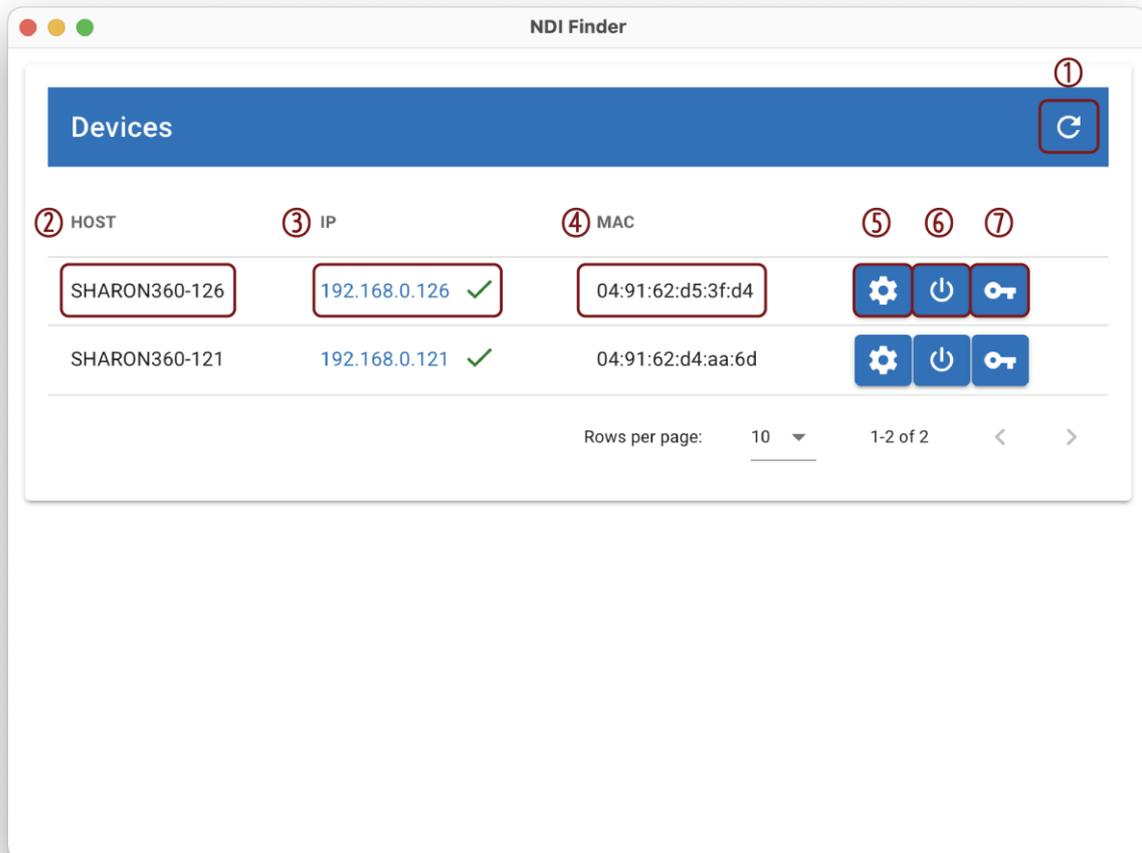

1. Click to refresh so that you can see the latest camera status.
2. The host name of the registered camera can be modified through button 5
3. If the camera's IP address is normally connected to the same network, it will appear in blue as above, and click the address to go to the web page.
4. Show the Camera's MAC address

5. After clicking, you can change the IP and hostname through the setting window below. After the change, the camera is rebooted.

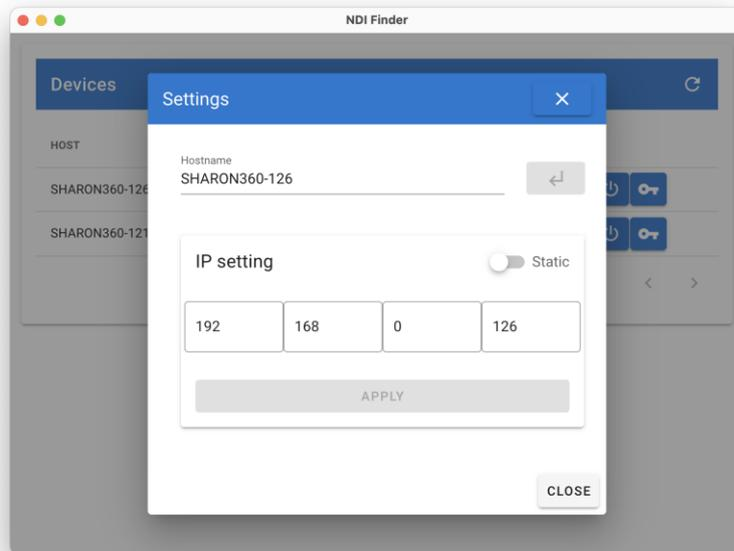

6. Camera Reboot

Initialize the admin account and password. After that, access the web page and reset the ID and password.

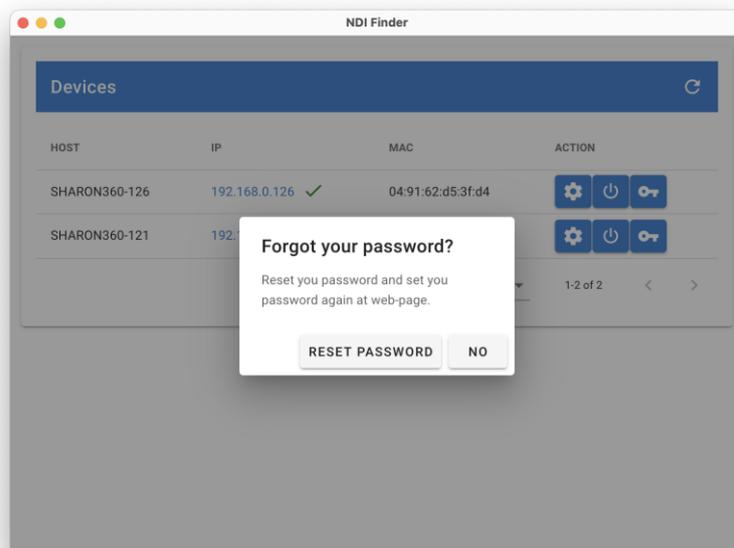

NDI Web-Server

If SHARON PTZs exists on the same network, you can access the web server through Chrome or another browser (Internet explorer, Edge) and Enter IP Address with a browser address and you will see the set password window as below.

Set Password

When you access the web server of SHARON NDI for the first time, the ID and password setting window appears.

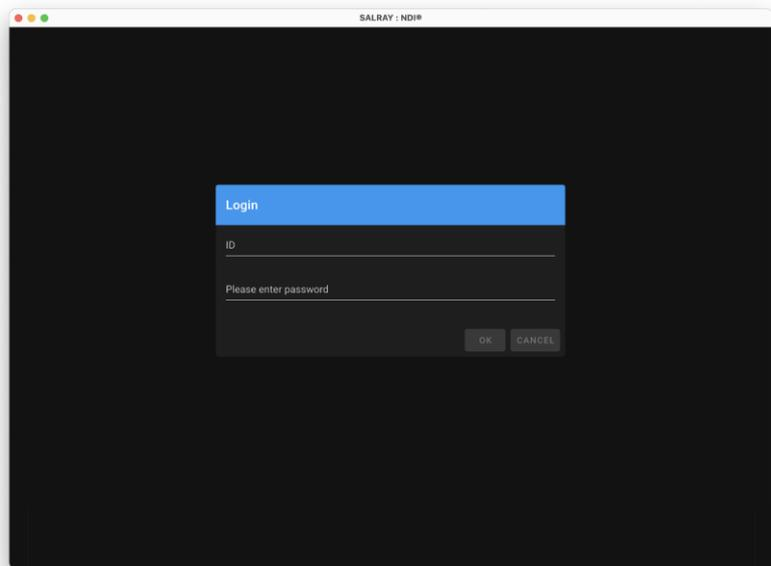

Network

After logging in you can access the network settings menu, and basically you can reset SHARON's hostname and address here and you can select your preferred NDI transmission method.

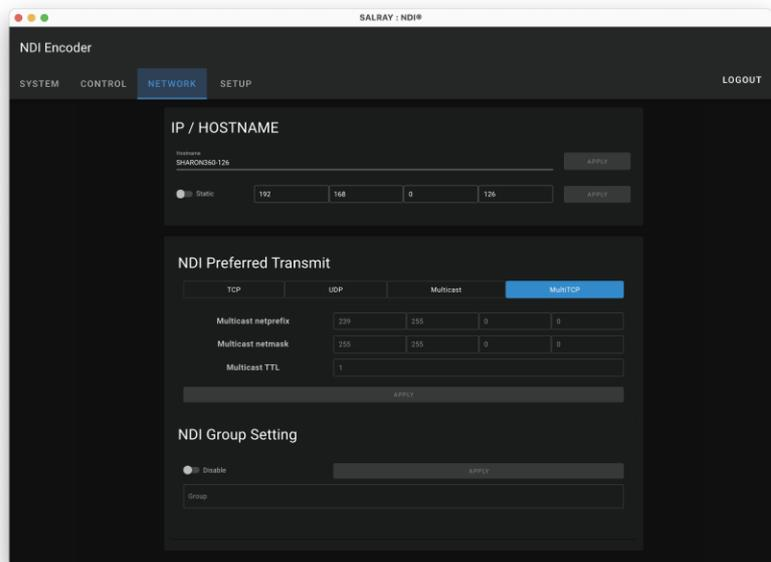

Control

In the control menu, the pan tilt of SHARON PTZ can be adjusted and up to 100 position values can be saved. The value can be freely adjusted by selecting the focus or exposure automatically or manually. Auto, Indoor, Outdoor, and Manual modes can be selected in White Balance menu.

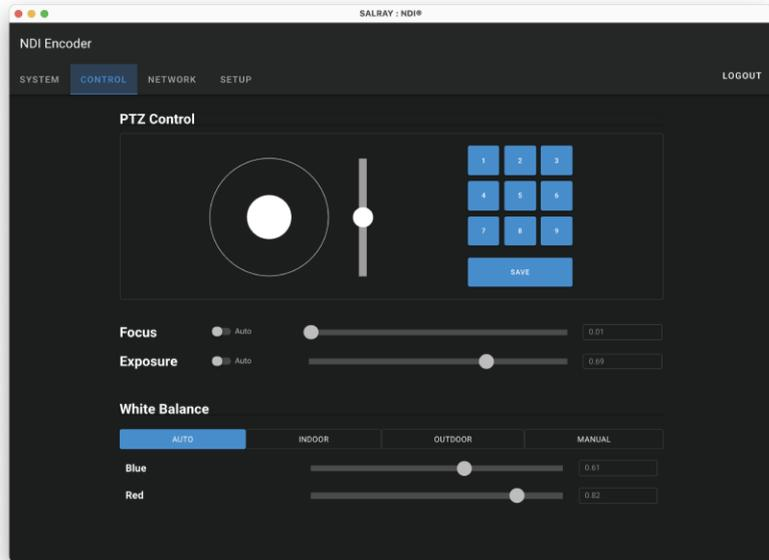

System

In the system menu, you can monitor the name, address, or information of the currently discovered Sharon device, the CPU, GPU, and network hatch of the current system. You can now monitor the video resolution of the Sharon PTZ camera and adjust the audio line or mic value. (The resolution can be changed by turning off the power and using the deep switch on the back of the SHARON camera.)

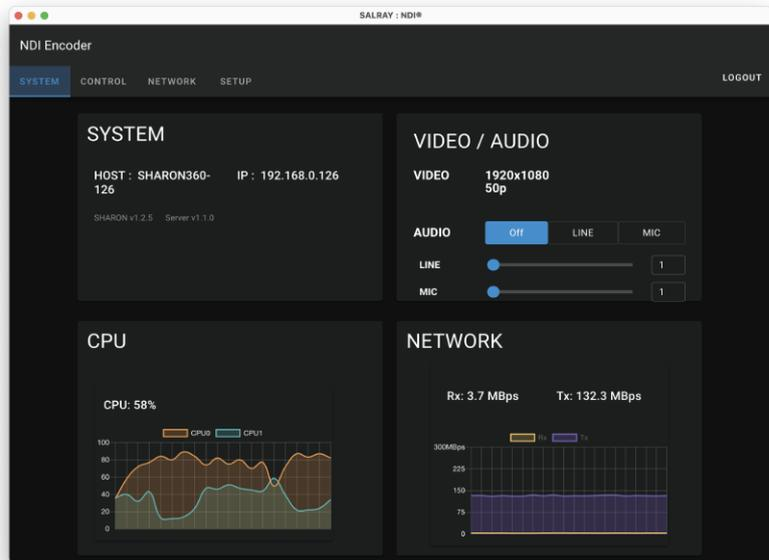

Setup

In the set-up menu, you can change the password and update the new firmware (the latest updated firmware can be downloaded from the download center of the homepage). Please check the current firmware version.

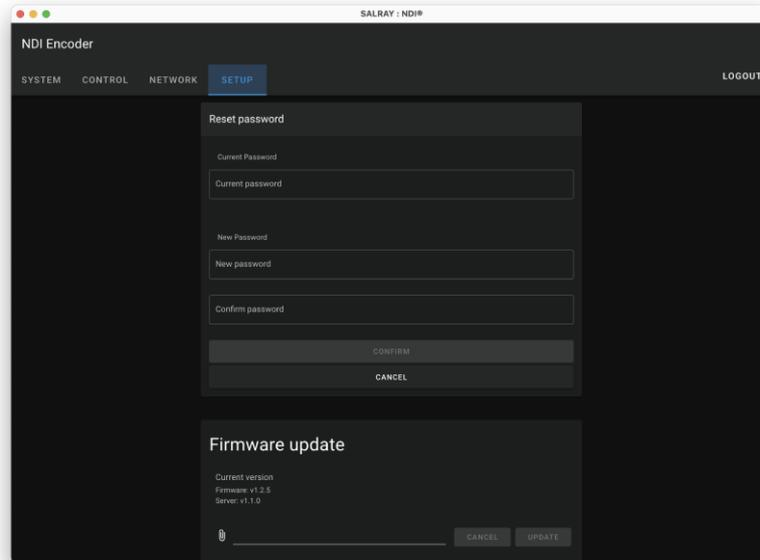

Controller

- C-K100 Controller for the SHARON PTZs

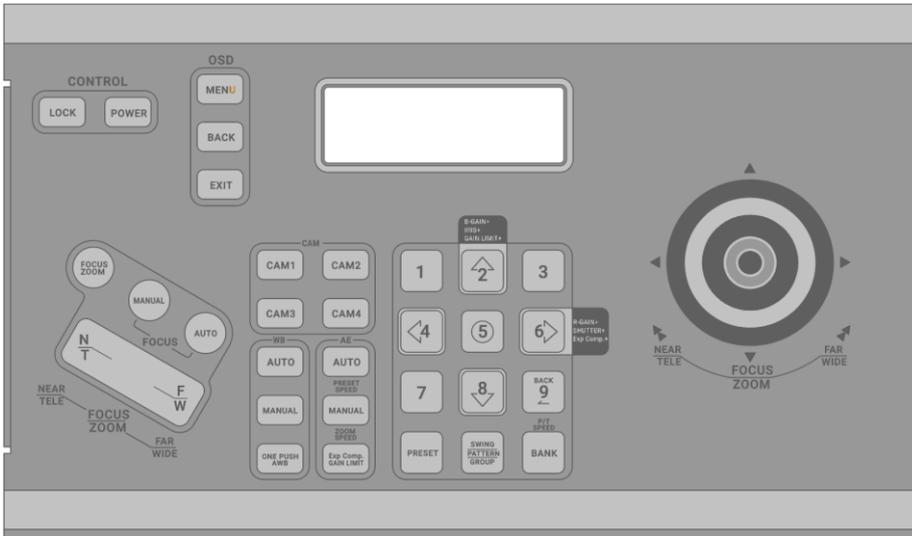

- Compact type keyboard controller
- Up to 4 cameras can be controlled
- LAN JACK support for convenient installation
- 422 communication interface
- LCD Display
- Variable speed control of PAN/TILT/ZOOM using the Joystick
- Easy control check through LED on each button
- Improved switch sensitivity by applying tact switch

* For more information, refer to the C-K100 manual

- C-K200 Controller for the SHARON PTZs

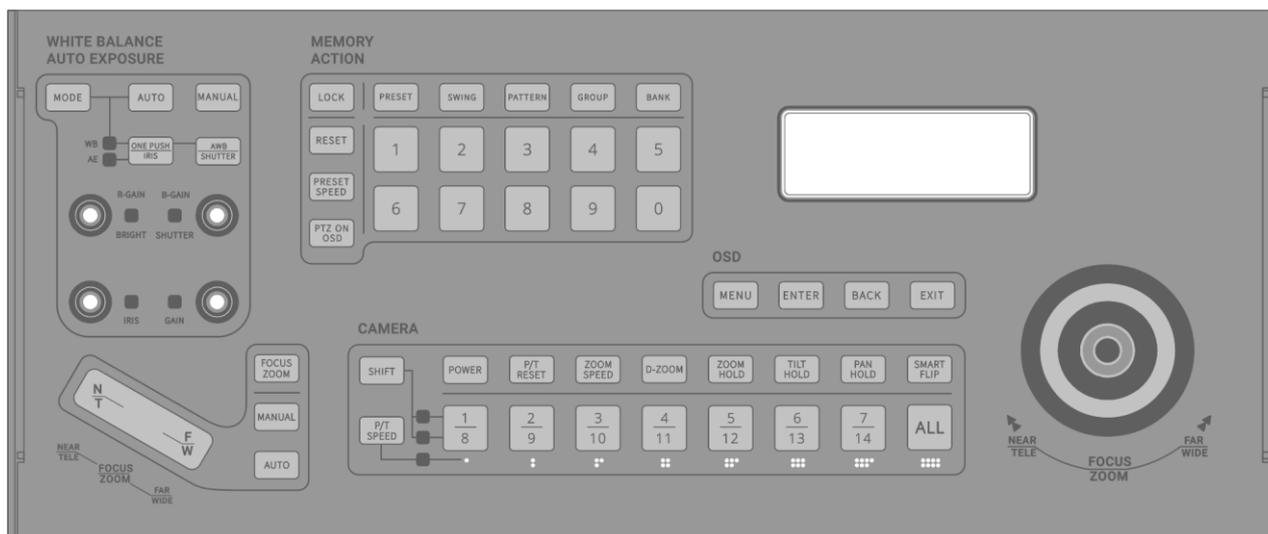

- Max. 14 Pan/Tilt/Zoom cameras can be controlled.
- Two-way remote control is supported by using RS-232C and RS-422 communication, and the camera operation status can be checked by button and LCD.
- Supports VISCA protocol.
- Available communication speeds are 9600bps and 38400bps.
- You can control the camera's Pan/Tilt speed using the joystick and speed button
- Fine adjustment is available. (Pan: 24 levels, Tilt: 23 levels, Zoom: 16 levels).
- 4 Line Text LCD is used to check and input the menu control operation status.
- You can easily operate Preset, Pattern, Swing and Group functions by using Function key.

* For more information, refer to the C-K200 manual

Problem Solving

If an error occurs in the camera, check the following.

If the problem persists after checking, please contact the distributor from whom you purchased this product.

Problem	Check
The image can't be seen.	Make sure that the power of this product and the monitor are connected.
	Make sure that the video cable is connected correctly.
	Check if the product support the output video format of the monitor.
	Check that the camera is illuminating directly with fluorescent light or direct sunlight. In this case, set BLC to ON in the camera exposure setting.
	Check the shutter speed of the OSD menu.
The controller does not work.	Check the controller's RS-422/485 and RS-232C and check the DIP switch setting of this product.
	Check that the controller ID matches this product ID.
	Check that the controller match the protocol and Baudrate of this product match.
The image is dark or bright.	Check the shutter speed and Brightness, Gain Limit, and Exp Comp settings.
There is noise in the image.	Make sure that the video cable is connected correctly.
	Power and video cable lengths should not be excessively long.
	Make sure that the operating temperature of this product is within the operating temperature range.
	Check the value of Gain, Aperture and Noise Reduction.
Picture quality is abnormal.	Check if the camera lens is dirty and remove it.
	Check the white balance.
When the power is turned on, the camera moves without stopping.	Make sure Power Up Action is set.

Menu Structure

You can check the all menu structure.

Please refer to the relevant page for more detailed function and usage.

* Bold letters indicate default values.

Main menu	1 st Submenu	2 nd Submenu	3 rd Submenu	4 th Submenu
<Focus/Zoom>	Focus Mode	Semiauto / Auto/ Manual		
	Focus Near Limit	1cm/ 11cm/ 30cm/ 0.8m / 1.2m/ 1.4m/ 1.65m/ 2.0m/ 2.5m/ 3.1m/ 4.2m/ 6m/ 10m/ 20m/ Over Inf		
	AF Sensitivity	Normal / Low		
	Digital Zoom	On/ Off		
	Zoom Speed(IR)	0~ 4 ~7		
<White Balance>	Mode	Auto 2500-7500K / Indoor 3200K/ Outdoor 5800K/ One Push/ ATW 2000-10000K/ Manual/ Outdoor Auto/ Sodium Auto/ Sodium/ Sodium Out Auto		
	Red Gain	0~ 211 ~255		
	Blue Gain	0~ 156 ~255		
<AE Mode>	Mode	Full Auto / Bright/ Shutter Pri/ Iris Pri/ Manual		
	Gain Limit	9.2dB~ 18.5dB ~43.1dB		
	Exp Comp	Off , -10.5dB~0dB~10.5dB		
	Shutter Speed	1/1~ 1/60 ~1/10000		
	Iris level	F1.6 ~F14, CLOSE		
	Gain level	0dB ~43.1dB		
	Bright Level	0~ 14 ~27		
<Picture>	Slow Shutter	On/ Off		
	BLC	On/ Off		
	WDR	On/ Off / VE		
	HR Mode	On / Off		
	Image Stabilizer	On/ Off / Hold		
	Day/Night	Day / Night/ Auto		
	Threshold Level	0~28		
<Image>	Image Flip	On/ Off		
	Defog Mode	Off / Low/ Mid/ High		
	Picture Effect	Off / Neg.Art/ B/W		
	High Sensitivity	On/ Off		
	Noise Reduction	Off/ 1~ 3 ~5		
	Gamma	Standard / Straight		
	Aperture	0~ 10 ~15		

	Freeze in Preset	On/ Off			
<Motion/Action>	<Motion>	Action Lock	On/ Off		
		Power Up Action	On/ Off/Home/ Preset1		
		Smart Flip	On/ Off		
		PT Direction	Normal		
		Preset Speed	300/sec		
		<PT SPEED>	PT Max Speed	60/sec	
			PT with Zoom	On	
			Acceleration	High	
		<Home Position>	Center		
	<North Direction>	Center			
	<Preset>	Preset No.	1~255		
		Clear Preset	Cancel/ Ok		
		<Edit Scene>			
		<Edit Label>			
		<Camera Mode>			
		Preset Speed	360/sec		
	<Swing>	Swing No.	1~8		
		Start Position	Preset 1~255		
		End Position	Preset 1~255		
		Swing Speed	30/sec, 1~180/sec		
		Clear Swing	Cancel/ Ok		
	<Pattern>	Pattern No.	1~8		
		Clear Pattern	Cancel/ Ok		
		<Edit Pattern>			
	<Group>	Group No.	1~8		
		Clear Group	Cancel/ Ok		
		<Edit Group>			
<Parking Action>	Park Enable	On/ Off			
	Wait Time	1min.~10min. ~4hour			
	Parking Action	Home, Preset, Swing, Group, Pattern			
<Display>	Display All	No			
	Camera ID	On/ Off			
	PTZ Information	On/ Off/ Auto			
	Flip status	On/ Off/ Auto			
	Action Title	On/ Off/ Auto			
	Preset Label	On/ Off/ Auto			
	IR Info.	On/ Off			
	<Area Label>	On/ Off/ Auto			
<System Info.>	Mecha F/W ver.				
	Video F/W ver.				
	System Select				

	Protocol				
	Baudrate				
	Camera ID				
	IR-Receive	On/ Off			
	〈Additional Info.〉	Camera Type			
		Camera ver.			
		Pan Rotation			
		〈System Initialize〉	Factory Default		
			Display Control		
			Camera Mode		
			Motion		
			Action		
Restart Zoom					
Restart System					

Default Value

Menu category	Saved Presets	Setting value	Default Value
Camera setting value			
Focus Mode	●		Semiauto
Focus Near Limit	●		0.8m
AF Sensitivity	●		Normal
Digital Zoom	●		Off
Zoom Speed	●		4
White Balance - Mode	●		Auto
Red Gain	●		211 (Auto value)
Blue Gain	●		156 (Auto value)
AE Mode - Mode	●		Full Auto
Gain Limit	●		18.5dB
EXP Comp	●		Off
Shutter Speed	●		1/60
Iris Level	●		F1.6
Gain Level	●		6.2dB
Bright Level	●		15
Slow Shutter	●		Off
BLC	●		Off
WDR	●		Off
HR Mode	●		On
Image Stabilizer	●		Off
DAY/NIGHT	●		Day
Threshold Level	●		0
Image Flip	●		Off
Defog Mode	●		Off
Picture Effect	●		Off
High Sensitivity	●		Off
Noise Reduction	●		3
Gamma	●		Standard
Aperture	●		10
Freeze in Preset	●		Off

User setting value			
Preset 1~ 255			Undefined
Swing 1~8			Undefined
Pattern 1~8			Undefined
Group 1~8			Undefined
Motion setting Value			
Action Lock		○	Off
Power Up Action		○	Off
Smart Flip		○	On
PT Direction		○	Normal
Preset Speed		○	360/sec
PT Max Speed		○	60/sec
PT with Zoom		○	On
Home Position		○	Center
North Direction		○	Center
Parking Action	Park Enable	○	Off
	Wait Time	○	00:10:00
	Park Action	○	Home
Display setting value			
Camera ID		○	Off
PTZ Information		○	Auto
Flip Status		○	Auto
Action Title		○	Auto
Preset Label		○	Auto
IR Info.		○	Off
System Info setting value			
IR Receive		○	On

● : Setting value is saved in the preset.

○: The last set value is restored even if the power is turned off and on again.

Specifications

Model		SHARON 30			SHARON 20			
Camera	Module	1/2.8inch "Exmor R" CMOS Sensor Sony Zoom Module			1/2.8 Type "Exmor R" CMOS Sensor			
	Valid pixels	1920[H]x1080[V] (Approximately 2.38 million pixels)			1920[H]x1080[V] (Approximately 2.12 million pixels)			
	Video output format	1080p60, 1080i60, 1080p30, 720p60, 720p30, 1080p59.94, 1080i59.94, 720p59.94, 1080p50, 1080i50, 1080p25, 720p50, 720p25						
	Video output	High bandwidth NDI, HD/3G-SDI(Level A/B), HDMI						
	Zoom Scale	Optical zoom: x30, Digital zoom: x12			Optical zoom: x20, Digital zoom: x12			
	Lens	30x Zoom Lens [f=4.3~129 mm F1.6~F4.7]			20x Zoom Lens [f=5.2~104mm, F1.5~F3.5]			
	Viewing Angle	63.7°(W), 2.3°(T)			63.5°(W), 3.5°(T)			
	Audio	Stereo Audio						
	IR INPUT	O						
	Minimum Luminance		Sec	High Sensitivity	Lx	Sec	High Sensitivity	Lx
			1/30	On	0.01	1/30	On	0.35
			1/30	Off	0.1	1/30	Off	1.4
			1/4	On	0.0013	1/4	On	0.05
			1/4	Off	0.013	1/4	Off	0.19
	Day & Night	AGC, TDN(ICR)						
	Focus	Semiauto/ Auto/ Manual						
	Image Flip	On/ Off						
	Zoom Speed	0~7						
	Focus Near Limit	0.8m/ 30cm/ 11cm/ 1cm/ Over Inf/ 20m/ 10m/ 6m/ 4.2m/ 3.1m/ 2.5m/ 2.0m/ 1.65m/ 1.4m/ 1.2m						
AF Sensitivity	Normal/ Low							
Defog Mode	Off/ Low/ Mid/ High							

	High Sensitivity	Off/ On
	Noise Reduction	Off/ 1~5
	Aperture	10, 0~15
	White Balance	Auto/ Indoor/ Outdoor/ One Push/ ATW/ Manual/ Outdoor Auto/ Sodium Auto/ Sodium/ Sodium Out Auto
	Program AE	Full Auto/ Bright/ Shutter Pri/ Iris Pri/ Manual
	WDR	Off/ On/ VE
	BLC	Off/ On
Pan/Tilt	Moving Angle	Pan: -172°~ 172°(Non-Endless) Tilt: total 220°(-20°~ 0°~ 180°~ -160°)
	Moving Speed	Manual: 0.002°/sec ~180°/sec (Interlocked with the Zoom Scale), Preset: 300°/sec, Swing: 1°/sec ~ 180°/sec
	Preset setup	255 Presets[VISCA], 255 Presets (Label setup, each display setup)[PELCO]
	Swing setup	8 Swings
	Pattern setup	8 Patterns
	Group setup	8 Groups (20 motions/Group)
	Other functions	Smart-Flip, Home Position Set, Auto Parking, Power Up Action etc.
Network	Interface	RJ45 LAN port, 1 Gigabit Ethernet
	Video compression	High Bandwidth NDI® : I-frame high bit rate protocol with ultra-low latency
	Network protocol	NDI® : Discovery, configuration and VISCA over IP control
	control interface	Full control via Web UI including Scene presets or NewTek NDI® applications To be supported: Mobile and PC
General	Cam ID	PELCO: 1~14, VISCA: 1~14 setting
	Communication	RS-422/485, RS-232C, IR Remote
	Protocol	PELCO-D/P, VISCA
	OSD	Menu, Position etc.
	Power	Fixed power supply: DC 12V ± 10% (Max Current 1.5A), PoE + (IEEE 802.3at) : 30W, up to 100 meters at 1Gbps
	Weight	Approximately 1.6Kg
	Operating temperature	0°C ~ 40°C(32°F~104°F)
	Working Environment	Indoor

Dimension

- PTZ Camera (SHARON 20/30 Series)

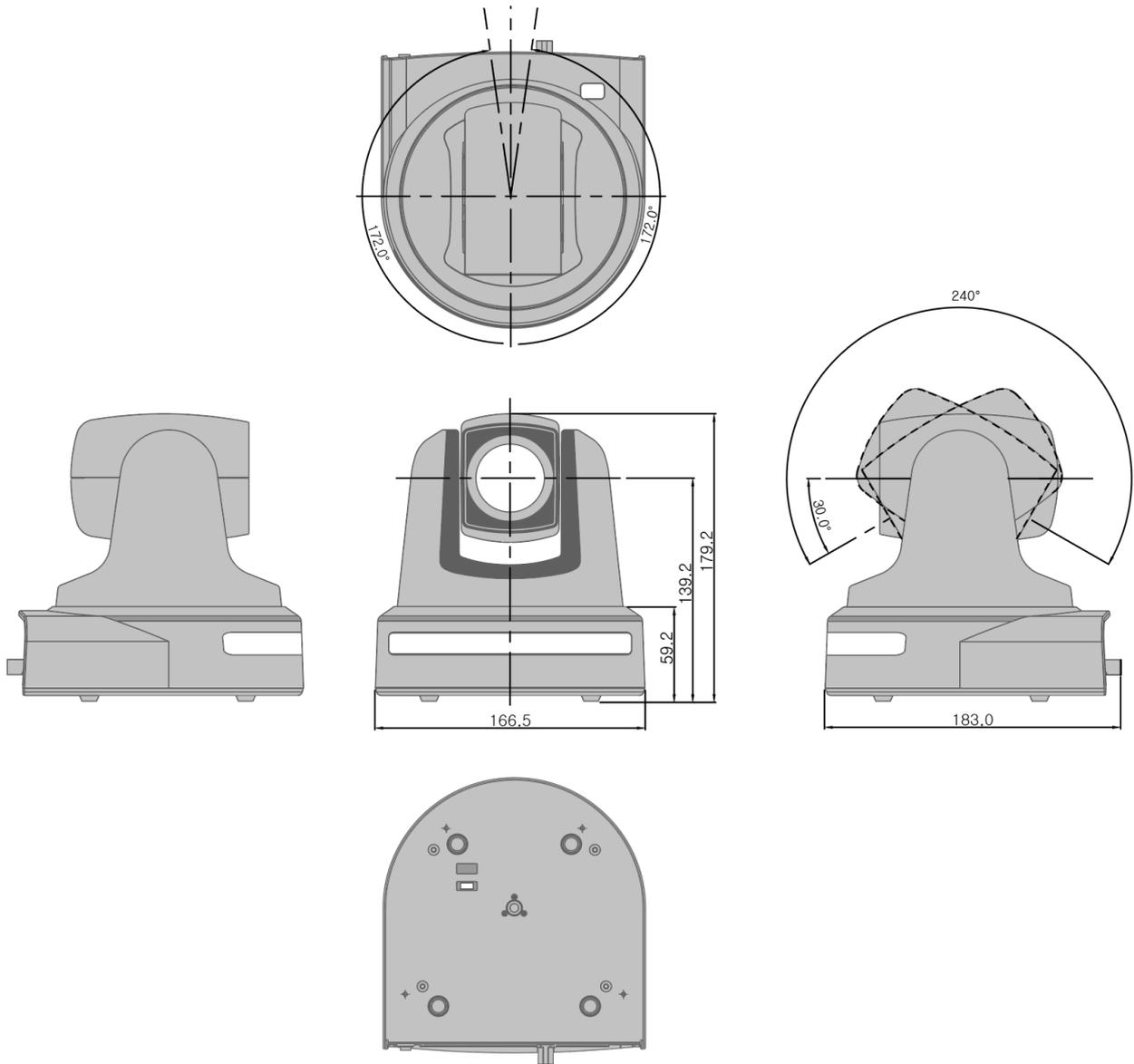

- Ceiling Bracket (ZCB-100)

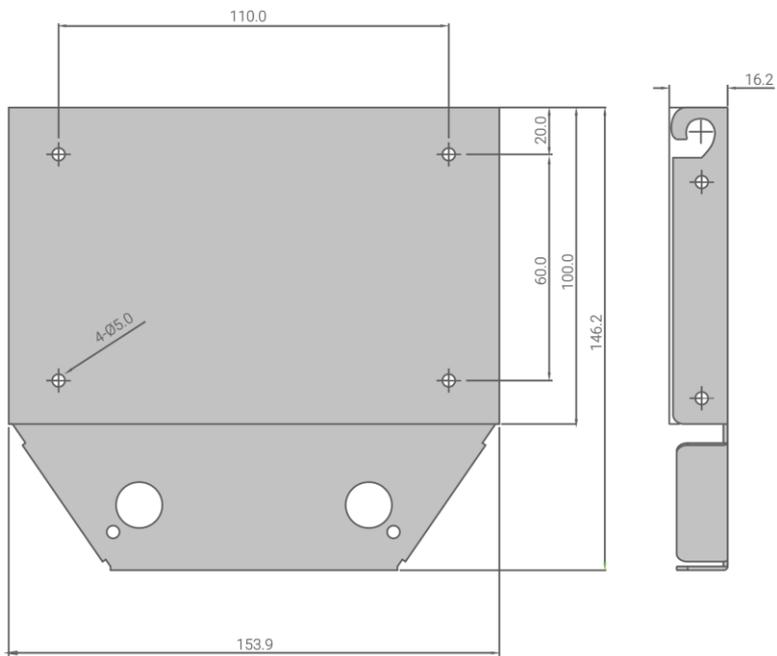

● Wall Bracket (ZWB-200) (Optional)

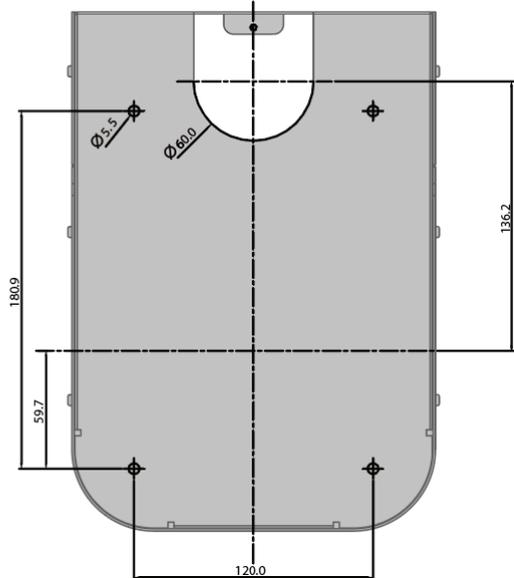
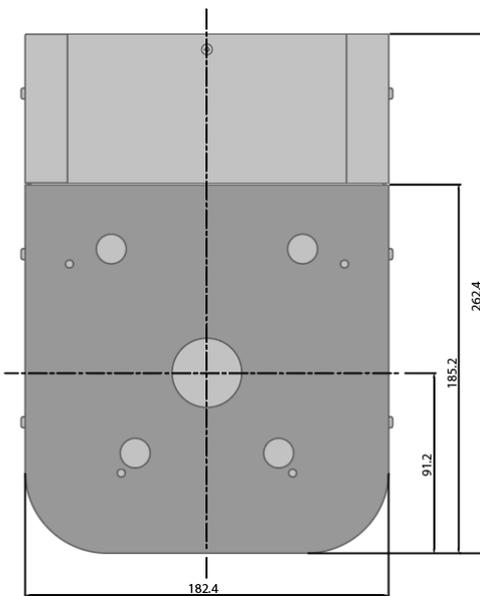
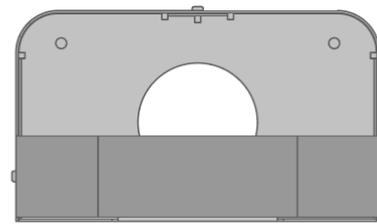
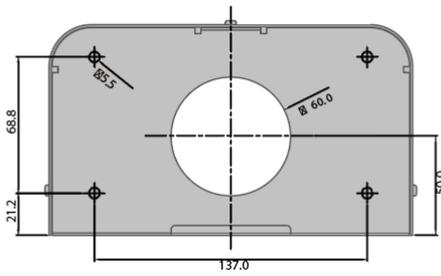
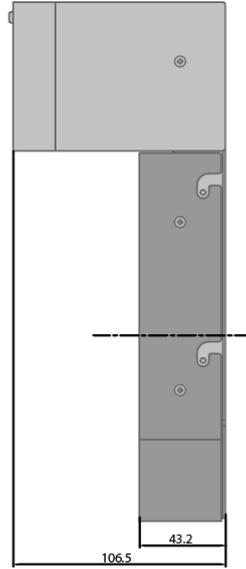
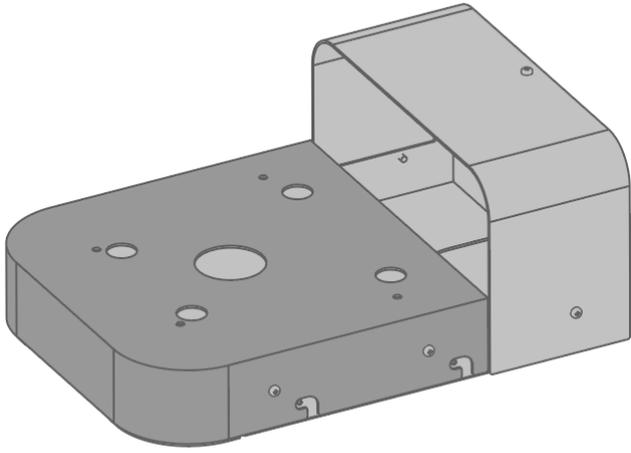

Glossary

- ◆ **HD-SDI(High Definition-Serial Digital Interface signal)**

The digital video interface with 1.5 Gb/s transfer rate is standardized in SMPTE 292M. It supports 1080i /59.94 signals and can transmit signals up to 208M (stable distance 145.6M) when coaxial cable is connected. The advantages of HD-SDI include no signal delay, video and audio reporting, and time code signals.

* The 3G-SDI standardized in SMPTE 424M supports transfer rate of 3.0 Gb/s and 1080p/60 signals. It can transmit signals up to 141M(stable distance 98.7M) when connecting coaxial cable.

- ◆ **HDMI(High Definition Multimedia Interface)**

The high-speed transmission standard that can integrate and transmit digital video and voice signals. It is mainly used in home appliances. The transmission distance is about 10 ~ 15M.

- ◆ **CVBS(Composite Video Blanking and Sync)**

The analog video output signal used before Digital. The two color difference signals are overlapped on one channel in the luminance signal. Basically, the deterioration is severe and the image quality is not good. The longer the transmission distance, the more noise and the lower picture quality.

- ◆ **VISCA**

The communication standard made by SONY to control PTZ camera.

- ◆ **PELCO D/P**

The communication standard using CCTV to control PTZ camera.

- ◆ **ONE PUSH**

This function adjusts the color based on the white paper in the center of the screen to adjust the white balance. It is distinguished from the AUTO function that automatically adjusts the closest color based on the displayed image, or the ATW function that reproduces the original color of the subject, excluding the influence of ambient light. The AUTO or ATW function can achieve the proper white balance, but it is recommended to use ONE PUSH to adjust more accurately.

- ◆ **IRIS**

In the camera, IRIS refers to the aperture. Iris is an important factor in determining depth, which improves image quality and depth so that you can see both distant and near objects clearly.

- ◆ **GAIN**

- ◆ It is a function to electronically amplify the signal when the light source is not illuminated enough and the image signal level is not enough. It is used when there is insufficient light on screen even if

all iris is open. However, since the amplification is forcibly amplified by using the electrical characteristics, noise may occur and may be a deterioration of image quality.

◆ **Shutter Speed**

This function sets the opening time of the shutter. Only when the shutter is open, the light is transmitted to the image sensor and the image is taken. For example, the lower the shutter speed is, the more vivid the dynamic image can be.

◆ **Digital ZOOM**

This function enlarges a part of image data by digital processing method and obtains zoom effect. Because it is software based rather than using hardware (lens), image quality deteriorates. It is commonly used as a supplement to optical zoom.

◆ **BAUDRATE**

It is the data transmission rate which indicates how many bits are transmitted per second to communicate. If the baudrate is 9600 bps, it means that 9600 bits are transmitted per second.

◆ **GAMMA**

Gamma is a figure of the response characteristics between the image brightness which is between the camera and the display receiving the input and the voltage. It is a function to ensure the contrast of the image when the signal sent from the camera is displayed on the display.

Index

A

Action Lock	29, 30
Action Title	35
Additional Info.....	39
AE Mode	26
AF Sensitivity	25
Aperture.....	28
Area Label	35

B

BAUDRATE	64
BLC.....	27

C

Camera ID	35
CVBS	63

D

Day/Night.....	27
Defog Mode.....	28
Digital Zoom.....	25
Digital ZOOM	64

E

Exp Comp.....	26
---------------	----

F

Flip Status.....	35
Focus Mode.....	25
Focus Near Limit	25
Freeze in Preset	28

G

GAIN	63
Gain Limit.....	26
GAMMA	64

H

HDMI.....	63
HD-SDI	63
High Sensitivity	28
Home Position	29
HR Mode.....	27

I

Image Flip.....	28
Image Stabilizer	27
IR Info.....	35
IRIS	63
IR-Receive.....	39

M

Mecha F/W ver.	39
---------------------	----

N

Noise Reduction	28
North Direction.....	29

O

ONE PUSH	63
-----------------------	----

P

Parking Action	23
PELCO D/P	63
Picture Effect.....	28
Power Up Action	23
Preset Label	35
PT Direction.....	29
PTZ Information.....	35

S

Shutter Speed	64
Slow Shutter.....	27
Smart Flip	23
System Select.....	39

T

Threshold Level.....	27
----------------------	----

V

Video F/W ver.	39
VISCA	63

W

WDR.....	27
----------	----

Z

Zoom Speed	25
------------------	----



GOD DESIGN
산업통상자원부산업장



Korean Intellectual
Property Office



SALRAYWORKS

Unit 905, 1126 Bemon-ro, Geumchon-gu, Seoul, Korea 08595, +82 2 2626 6425, anyhelp@salrayworks.com

www.salrayworks.com