TX-85E controller / MT-PT60B Robotic Head

Robotic PAN/TILT Head / PTZ CAM Controller

User Manual

Ver 1.2



SALRAYWORKS

Contents

Caution.....	3
Important Safeguard.....	4
Pre-Caution	4
Introduction	5
MT-TX85E QUICK MANAUL.....	7
1. Overview.....	7
2. Model Name and Key features.....	7
3. Features.....	7
4. Communication.....	8
5. Physical.....	8
6. Function.....	9
7. Interface.....	9
8. Connectors Spec.....	9
9. Display.....	10
10. Camera Selection.....	10
11. Camera Power.....	10
12. BALCLIGHT.....	11
13. AWB.....	11
14. Image Flip.....	11
15. PAN/TILT Reset.....	11
16. L/R Button.....	12
17. Menu Button.....	12

18. Focus, Bright and Iris Control	12
19. FOCUS Mode	12
20. PUSH	13
21. IRIS	13
22. Preset (VISCA PTZ CAMERA)	13
23. ZOOM Speed	14
24. PAN/TILT Speed	14
25. CONFIG	14
26. Calibration	15
27. Controller Serial Connection	16
MT-PT60B	
1. Setting Panel	17
2. Connector Spec	20
Basic Mounting Guide on the Tripod	
1. Components	20
2. How to Mount	21
3. Camera-Setup	26
Appendix-A. Handheld Camera model function compatibility Table	27
Appendix-B. MT-TX85E & MT-PT60B Wiring Diagram	29
Appendix-C MT-PT90 & MT-PT60B Wiring Diagram	30

Caution



Caution
Don't open. There may be electric



<Caution

To avoid the risk of electric shock, do not arbitrarily open the cover or disassemble the product. There are no user serviceable replacement parts. Get service from qualified service personnel.



This lightning flash with arrowhead symbol is intended to alert the user to the presence of un-insulated "dangerous voltage" within the product's enclosure that may be of enough magnitude to constitute a risk of electric shock to person.

<Caution

To reduce the risk of fire or electric shock, do not expose this product to rain or moisture.



This exclamation point symbol is intended to alert the user to the presence of important operating and maintenance(servicing) instructions in the literature accompanying the appliance.

Important Safeguard

- ♦ Read all the safety and operating instructions before using the product.
- ♦ Save these instructions for future reference.
- ♦ Do not use attachments or accessories unless recommended by the appliance manufacturer as they may cause hazards, damage product and void warranty.
- ♦ Do not use this product near water or moisture.
- ♦ Do not place or mount this product in or on an unstable or improperly supported location.
- ♦ Improperly installed product may fall, causing serious injury to a child or adult, and damage to the product. Use only with amounting device recommended by the manufacturer or sold with the product. To ensure proper mounting, follow the manufacturer's instructions and use only mounting accessories commended by manufacturer.
- ♦ This product should be operated only from the type of power source indicated on the marking label.

Precautions

- ♦ Before using, make sure power supply and others are properly connected.
- ♦ While operating, if any abnormal condition or malfunction is observed, stop using the PAN/TILT head immediately and then contact your local dealer.
- ♦ Do not disassemble or tamper with parts inside the camera.
- ♦ Do not drop or subject the PAN/TILT head to shock and vibration as this can damage PAN/TILT head
- ♦ Care must be taken when you clean the clear dome cover. Especially, scratch and dust will ruin your quality of camera.
- ♦ Do not install the PAN/TILT head in areas of extreme temperature, which exceed the allowable range.
- ♦ Avoid installing in humid or dusty places.
- ♦ Never expose the camera to rain and water.
- ♦ Avoid installation in a place with radioactivity. It may cause a malfunction of the part.
 - ♦ Avoid installation in locations with strong magnetic fields or electrical signals.
 - ♦ Avoid installing in places where the PAN/TILT head would be subject to strong vibrations.

The ROBOTIC PAN/TILT HEAD Controller from Salrayworks is a designed for hand-held cameras with MT-PT60B as all precision gear products and high-quality mechanical components. A rugged PAN/TILT head is one that's designed specifically to operate reliably in a harsh indoor environment. That could be an environment that's subject to lots of vibration, extreme temperatures or dust conditions. The head can be mounted on a tripod or on a wall, ceiling, or surface, and fully controllable by TX-85E or TX-90 Controller.

The MT-PT 60/60P head enable shooter to choose the most suitable camera and lens for their production. You can remotely control the using LANC protocol (SONY, CANNON, JVC, Black-Magic Design) or Panasonic Protocol (Panasonic Camera) via RS 422.

1. Overview

This controller is a dedicated remote device that can remotely control MT-PT60B PAN/TILT head. Up to 7 MT-PT60B can be connected and controlled.

2. Model Name and Key features

- 1) MT-TX85E 1
- 2) VISCA. PELCO-D Protocol
- 3) PAN/TILT, ZOOM, FOCUS control
- 4) PAN/TIL and ZOOM speed control in 4 steps.
- 5) easy and smooth joystick operation
- 6) White Balance Setting (Manual / Auto)
- 7) Image Flip function

3. Features

- 1) J-100R
 - A. Camera status indicator lamp Front
 - B. Camera status control button Front
 - C. ZOOM control joystick Front
 - D. PAN, TILT control joystick Front
 - E. Power supply port Front (DC12V 1A)
 - F. Camera communication port Rear (RS-232 , RS-422)
 - G. Setting switch Rear DIP SWITCH)
 - H. UPDATE Port Rear (RJ-11-6P)

4. Communication

1) Serial Data

- A. Interface..... RS-232 x (Not Used) 1, RS-422 x 1
- B. Data Speed 9600bps . 38400bps, 1stop, 8Bits Data, No Parity.
- C. Data Structure One Start, One Stop, 8bits Data, No Parity

5. Physical

- 1) SIZE (W X H X D) : 280 x 196 x 60 mm
- 2) Weight 2Kg

6. Function (Front)

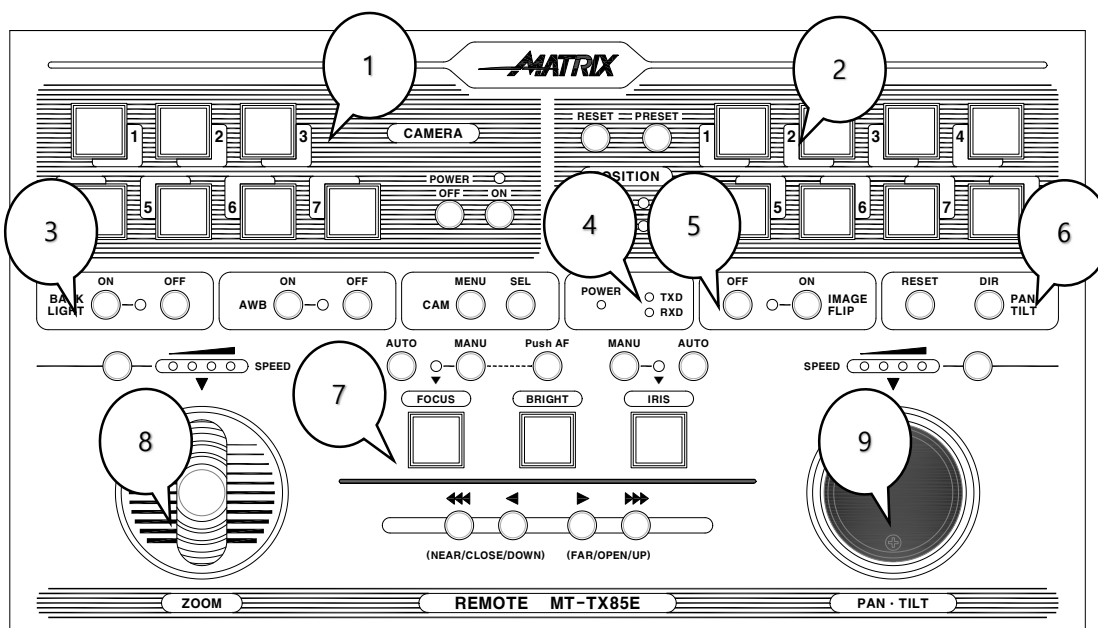

- 1) CAMERA Select Button
- 2) PRESET Select Button
- 3) BACK LIGHT, AWB Button
- 4) Power Status, Data Status, MENU Button
- 5) IMAGE FLIP ON/OFF Button
- 6) PAN/TILT RESET, L/R DIR Button
- 7) FOCUS, BRIGHT, IRIS Button
- 8) ZOOM control Joystick
- 9) PAN/TILT control Joystick

7. Interface (Rare side)

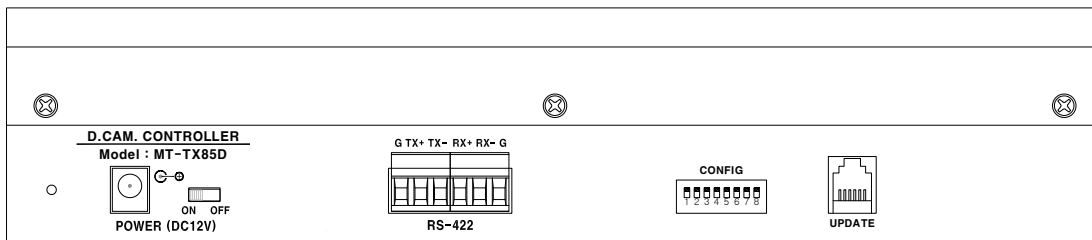

- 1) POWER (DC 12V) Input port
- 2) Power ON/OFF switches
- 3) RS-232 data port (Not Used)
- 4) RS-422 data port
- 5) CONFIG setting
- 6) UPDATE port

8. Connector Spec

- 1) RS-422

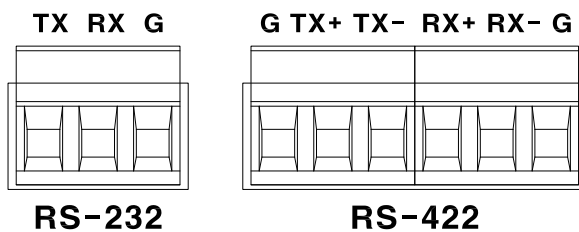

- 3) UPDATE

It is used by the manufacturer as a firmware upgrade port, and the user cannot operate it.

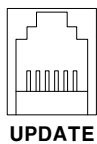

9. Display of equipment power and communication status.

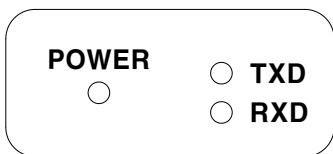

- 1) If the power supply to the remote device is normal, the POWER LED is turned on.
- 2) When transmitting data from remote, TXD LED turns on.
- 3) When receiving data from the camera, RXD LED turns on.

10. Camera selection function

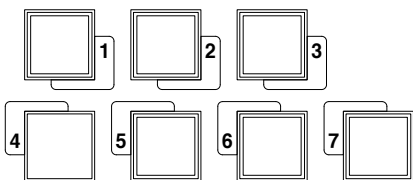

- 1) You can select 7 cameras from cameras 1 to 7.
- 2) After selecting the camera, it takes about 1 to 2 seconds to establish a communication connection with the camera.

11. Camera power control (VISCA/PELO based PTZ Camera only)

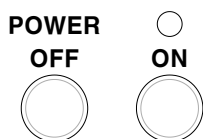

- 1) When the ON button is selected, the power ON command is sent to the camera, and the LED is turned on.
- 2) If you select the OFF button, the power OFF command is sent to the camera, and the LED turns off.

12. BACKLIGHT Button (VISCA/PELO based PTZ Camera only)

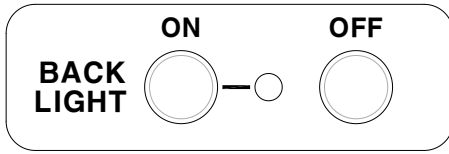

- 1) When the ON button is selected, the ON command is transmitted, and the LED turns ON.
- 2) If the OFF button is selected, the OFF command is transmitted, and the LED turns OFF.

13. AWB Button (VISCA/PELO based PTZ Camera only)

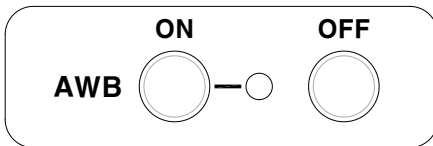

- 1) If you select the AWB ON button, it changes sequentially as follows.

AUTO -> INDOOR -> OUTDOOR -> OPW -> USER

- 2) If AWB OFF button is selected, AUTO mode is selected.
- 3) LED is OFF in AUTO mode and ON in other modes.

14. IMAGE FLIP ON/OFF (VISCA/PELO based PTZ Camera only)

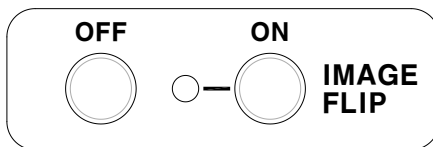

- 1) If you select the ON button, the function is activated, and the LED turns ON.
- 2) If you select the OFF button, it is restored, and the LED turns off.

15. PAN/TILT RESET (VISCA/PELO based PTZ Camera only)

- 1) Select the PAN/TILT initialization function.
- 2) If you hold it down for 2 seconds or longer, it is selected by the PAN/TILT HOME function.

16. L/R DIR Button (VISCA/PELO based PTZ Camera only)

- 1) Select the opposite direction of the right and left of the camera movement direction.

17. MENU Button (VISCA/PELO based PTZ Camera only)

- 1) If you select the MENU button, you can see the setting screen of the camera.
- 2) Move the item using the PAN/TILT joystick.
- 3) Select an item using the SEL button.
- 4) To exit the setting screen, select the MENU button.

18. FOCUS, BRIGHT, IRIS control (VISCA/PELO based PTZ Camera only for Bright)

- 1) To use the FOCUS, BRIGHT, and IRIS functions, you must use the select button.

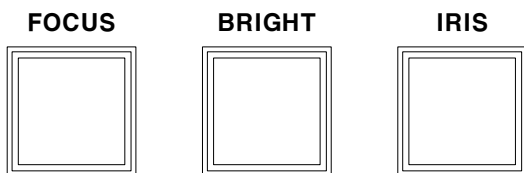

- 2) After selection, use the direction buttons to control the corresponding function.

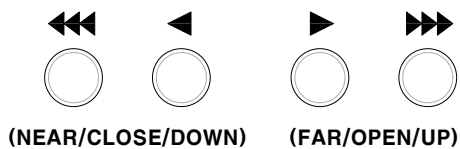

- 3) BRIGHT (VISCA PTZ Camera only) and IRIS control is applied only when IRIS mode is MANUAL.

19. FOCUS MODE Button

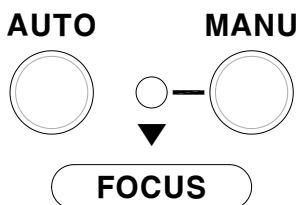

- 1) If you select the AUTO button, the LED turns off and operates in AUTO mode.
- 2) If you select the MANU button, the LED turns on and operates in MANUAL mode.

20. PUSH AF Button

- 1) Press PUSH for 3 seconds to operate (and press for 3sec to function as AF)
- 2) It works only in MANUAL mode.

21. IRIS MODE Button

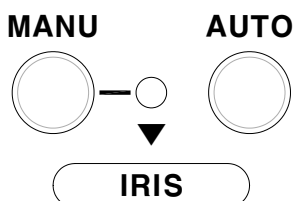

- 1) If you select the AUTO button, the LED turns off and operates in AUTO mode.
- 2) If you select the MANU button, the LED turns on and operates in MANUAL mode.

22. PRESET Button for VISCA PTZ CAMERA

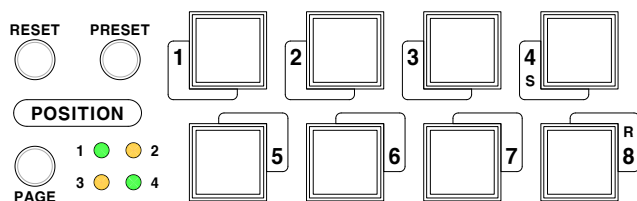

- 1) You can select 32 presets in 4 groups of 8 each.
- 2) Move 4 groups by using the PAGE button.
- 3) If you select the number button, the preset is executed.
- 4) Hold down the RESET button and select the number
The preset memory value is cleared.
- 5) While holding down the PRESET button, if you select the number button,
Save your current location.

⚠ Caution Does not apply to MT-PT60B Robotic Head.

23. ZOOM SPEED Selection

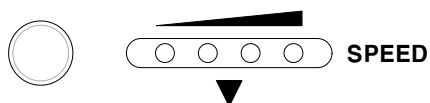

1) If you select the button, it changes to step 1 -> 2 -> 3 -> 4. (1 is the slowest and 4 is the fastest)

24. PAN/TILT SPEED Selection

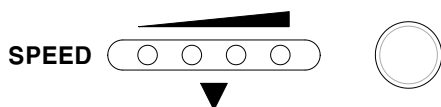

1) If you select the button, it changes to step 1 -> 2 -> 3 -> 4. (1 is the slowest and 4 is the fastest)

25. CONFIG Switch

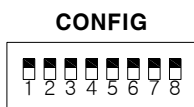

1) No. 1 ~ No. 4: Select the camera type.

1	2	3	4	PTZ Camera Model
OFF	OFF	OFF	OFF	
ON	OFF	OFF	OFF	
OFF	ON	OFF	OFF	HD150 (BOLIN/ Bird-dog)
ON	ON	OFF	OFF	Z330 (SONY)
OFF	OFF	ON	OFF	A60S (Lumens)/ Salrayworks / 60b_VISCA
ON	OFF	ON	OFF	
...				
ON	ON	ON	ON	

2) No. 5: Not used.

3) No. 6: Select communication method

OFF: RS-232

ON: RS-422

4) No. 7: Select communication speed
 OFF: 9600BPS
 ON: 38400BPS

5) No. 8: Test mode5

- A60S (LUMENS PZT camera case or its all-OEM PTZ camera case) Camera precautions--

- 1) If you select the FOCUS button and the BRIGHT button at the same time, it changes to the RED GAIN function.
- 2) If IRIS button and BRIGHT button are selected at the same time, it is changed to BLUE GAIN function.
- 3) IRIS and BRIGHT control function work only in IRIS MANUAL mode. (Camera characteristics)
- 4) RED GAIN or BLUE GAIN control function works only when AWB mode is MANUAL.
 When the AWB LED is off, press the AWB button 5 times.
- 5) In RED GAIN or BLUE GAIN mode, if you press the ◀ button and ▶ button at the same time,

The RED GAIN or BLUE GAIN value is reset. (Camera characteristics)

25. Joystick calibration method

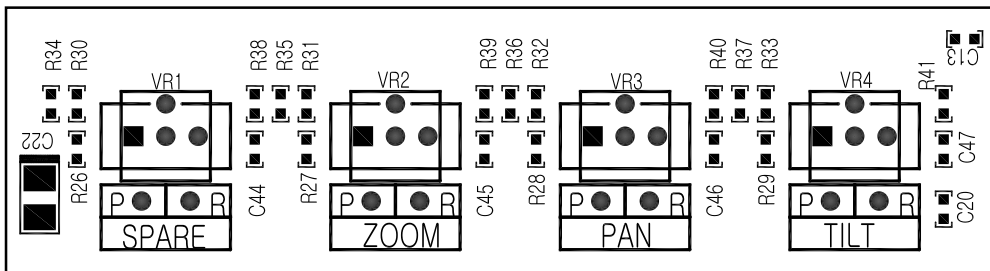

- 1) Measure the center values of ZOOM, FOCUS, and PAN as voltage at point P without touching the joystick.
- 2) Adjust VR2, VR3, VR4 to equalize the voltage of R point.
- 3) In general, 1.65V is the center value.
- 4) If the position of the center is changed due to the use of the joystick for a long time
 Measure the voltage at point P and correct the voltage at point R using VR.

26. controller Serial connection

RS 422 signals are serially communicated through CAT5 or LAN cables.
(Must be Used with 3 M)
RS422 Terminal Block (Green Head) we provide in Controller package,



As shown in the picture above, cut the head of the LAN cable and insert the terminal block with the color below.

LINE-1: white/orange = TX+

LINE-2 : Orange = TX -

1. Setting Panel

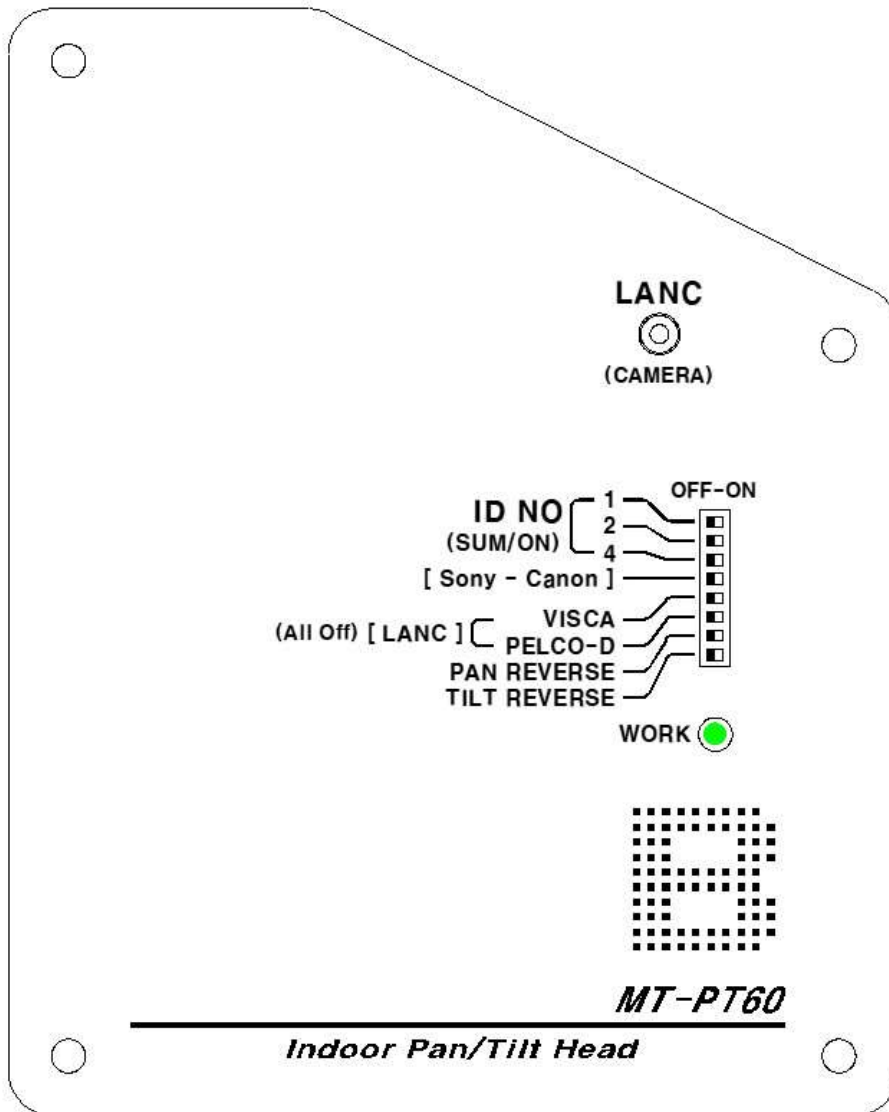

1-1. LANC (CAMERA)

- It is a port to connect the connector that controls the camera.
- Use a cable with a 2.5mm stereo jack connector.

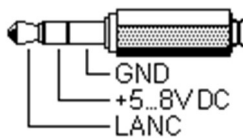

1-2. WORK (LED,Green)

- It is a green LED indicating equipment status.
- If the power is supplied normally, it blinks at 1 second intervals.
- When a pan/tilt control command is received and operated from the remote device, it blinks at 0.3 second intervals.

A. Select Operation Mode



B. ID NO 1,2,4

- Set the ID selected on the remote device using PELCO-D or VISICA protocol.

ID	ID NO 1	ID NO 2	ID NO 4
1	ON	OFF	OFF
2	OFF	ON	OFF
3	ON	ON	OFF
4	OFF	OFF	ON
5	ON	OFF	ON
6	OFF	ON	ON
7	ON	ON	ON

C. Sony, Canon Camera Case

- Choose the type of camera

	Camera Brand	Protocol Type
OFF	SONY Black Magic Design Panasonic	LANC
ON	CANNON	OK LANC

D. LANC – VISCA – PELCO-D

- Choose the type of Protocol

Remote Protocol	VISCA	PELCO-D	Controller
LANC	OFF	OFF	MT-TX80 MT-TX90
VISCA	ON	OFF	MT-TX85E
PELCO-D	OFF	ON	MT-TX85E

E. PAN REVERSE

- When ON, the left and right directions are changed to operate in the reverse direction.

F. TILT REVERSE

- When ON, the vertical direction is changed to operate in the reverse direction.

2. Connector Spec

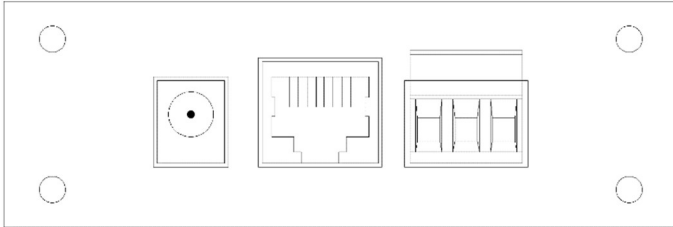

2-1. Power terminal

-Supply DC 24V power

2-2. RJ-45 terminal

-Connect with remote equipment.

PIN.1	: RXD+	Orange White
PIN.2	: RXD-	Orange
PIN.3	: GND	Green White
PIN.4	: NC	Blue
PIN.5	: NC	Blue White
PIN.6	: GND	Green
PIN.7	: TXD+	Brown White
PIN.8	: TXD-	Brown

2-3 Green terminal

-Connect with remote equipment. (It cannot be used simultaneously with the RJ-45 terminal.)

PIN.1	: RXD+	First from the right
PIN.2	: RXD-	Second from the right
PIN.3	: GND	Third from the right

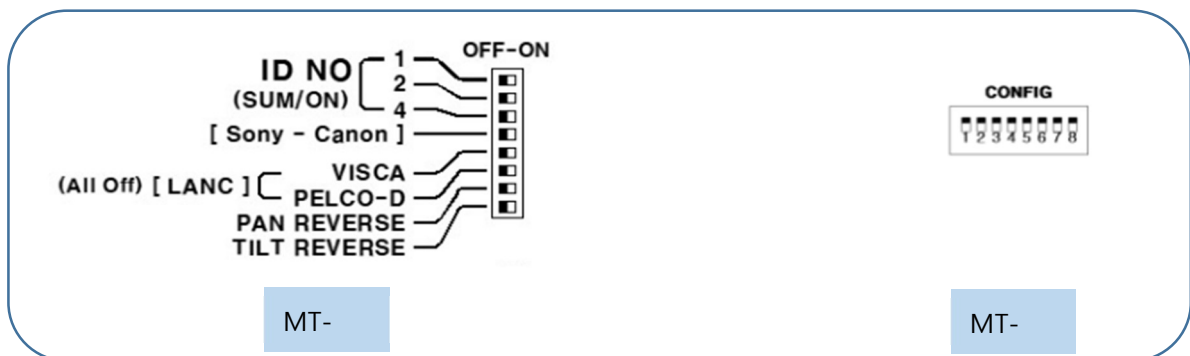

*ID No.

Set the ID selected on the remote device using the PELCO-D or VISICA protocol.

ID 번호	ID NO 1	ID NO 2	ID NO 4
1	ON	OFF	OFF
2	OFF	ON	OFF
3	ON	ON	OFF
4	OFF	OFF	ON
5	ON	OFF	ON
6	OFF	ON	ON
7	ON	ON	ON

	MT-PT60	MT-TX85E
VISCA in use	VISCA ON	3:ON , 6:ON
PELCO-D in use	PELCO-D ON	1:ON, 3:ON , 6:ON

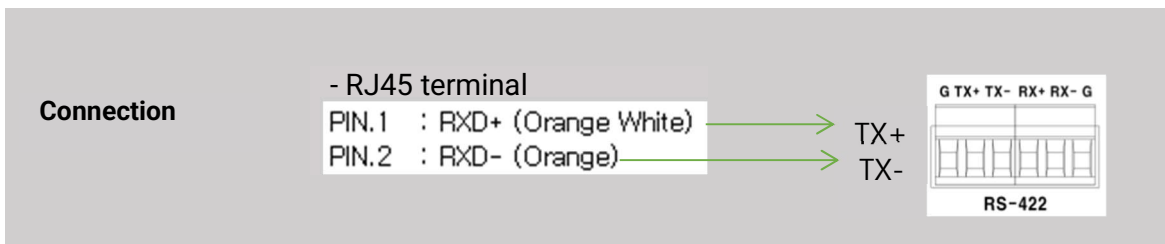

Basic Mounting Guide on the Tripod

To install on the tripod, you must purchase the corresponding option separately.

1. Components.

- 1 x Large Hex Bolt
- 4 x Small Hex Bolts
- 1 x Flange
- 1 x Dock Washer
- 1 x Adaptor Panel



2. Put the Adaptor panel on the TriPort and tighten to Large Hex Bolt into Tripod



3. Put the Dock Washer on the other side and use a Spanner tightens it with flange.



4. Put MT-PT60B on Adaptor Panel and tighten 4 screws.



5. Adjustable range of PAN and TILT



The Maximum angle can be adjusted with a screw.

PAN Angle: Default Set - 90° to + 90° and Max 350°

TILT Angle: Default Set 15 °to 30° and Max 160°

6. Connect the MT-PT60 (or MT-PT60P) and the Controller (MT-TX80/TX90) with the given LAN (RS422) Cable.

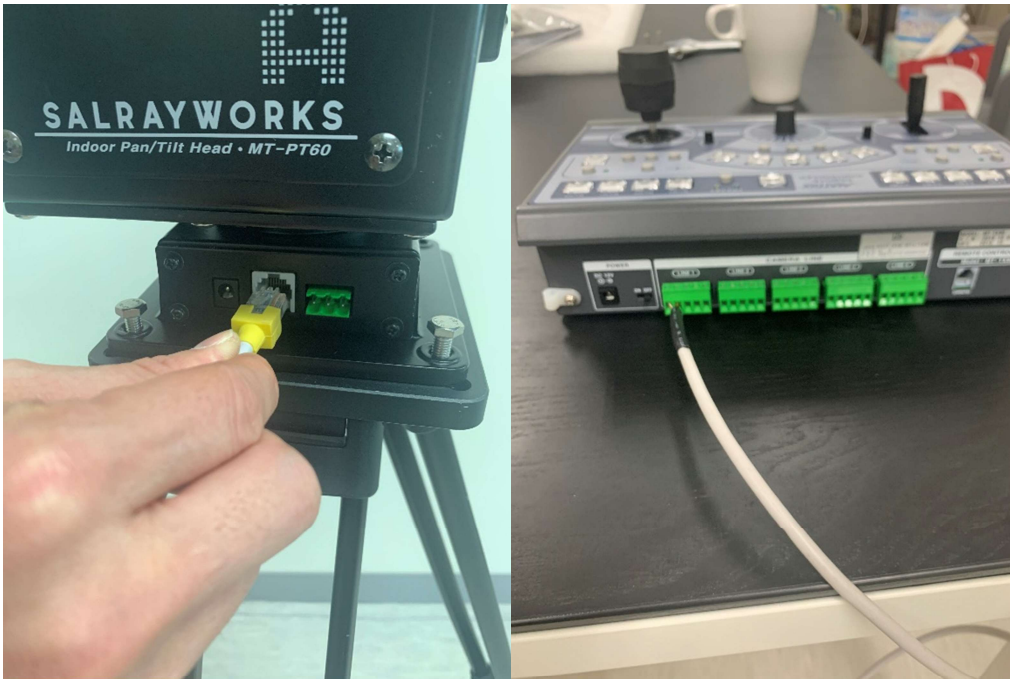

7. Secure the Camera to the PAN/TILT Head by turning the screw.



8. It must be fixed stably without sharking with spanner or tool.



9. Please find "REMOTE " port " at your Camera and connect to 2.5 MM stereo cable.



10. Connect 2.5 MM stereo cable to PAN/TILT Head as below picture.



11. Please go to “Display output “at your Camera MENU, then set as “All OUTPUT “





12. If your camera has STEADY SHOT option, and then should set as "OFF "

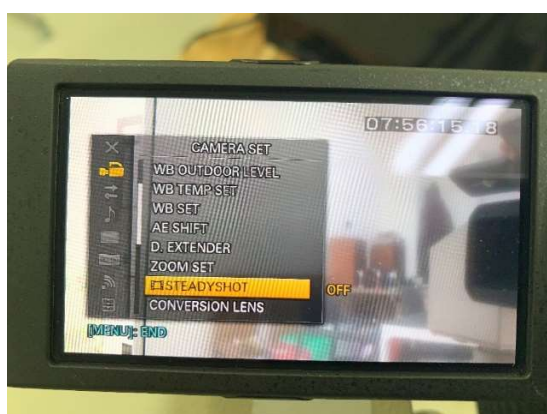

Appendix-A

<i>Handheld Camcorder Model</i>	<i>Compatible LANC type Model or Lenses Model</i>	<i>ZOOM. Focus, IRIS function</i>	<i>ZOOM, Focus, IRIS. GAIN. AWB, Shutter, Menu, REC, Display on/off. Assign full function</i>
SONY	NX, Z, X, FS series	MT-TX85E	MT-TX 90
CANNON	CINE series	MT-TX85E	MT-TX 90
	XA Series	MT-TX85E	MT-TX 90
	XF Series	MT-TX85E	MT-TX 90
JVC	HC Series	MT-TX85E	NO
	HM Series	MT-TX85E	NO
Black-Magic Design Studio / Micro Studio Camera 4K	Panasonic Lumix G X Vario PZ 14-42mm f/3.5-5.6 Power OIS lens	MT-TX85E	NO
	Panasonic Lumix G X Vario PZ 14-42mm f/4.0-5.6 Power OIS lens	MT-TX85E	NO
	Olympus 12-40mm f/3.5-6.3 ED M.Zuiko EZ Micro 4/3 Lens	MT-TX85E	NO
	Olympus 14-42mm M. Zuiko f/3.5-5.6 Digital ED/EZ Lens	MT-TX85E	NO
Black-Magic Design Studio / URSA Broadcast With B4 Mount	Fujinon LA16x8BRM-XB1A,	MT-TX85E	
Black-Magic Design Studio / URSA Mini Pro with B4 Mount	Fujinon LA16x8BRM-XB1A,	MT-TX85E	
Blackmagic Micro Cinema Camera	Lens Control Iris, focus and zoom on supported lenses.	MT-TX85E	

<i>Handheld Camcorder Model</i>	<i>Compatible LANC type Model or Lenses Model</i>	<i>ZOOM. Focus, IRIS function</i>	<i>ZOOM, Focus, IRIS. GAIN. AWB, Shutter, Menu, REC, Display on/off. Assign full function</i>
PANASONIC	DVX Series (LANC)	MT-TX85E	NO
	UX Series (LANC)	MT-TX85E	NO
	AC Series (LANC)	MT-TX85E	NO
	CX Series(LANC)	MT-TX85E	NO
	BGH1	MT-TX85E	

Appendix-B .

MT-TX85E & MT-PT60 Wiring Diagram

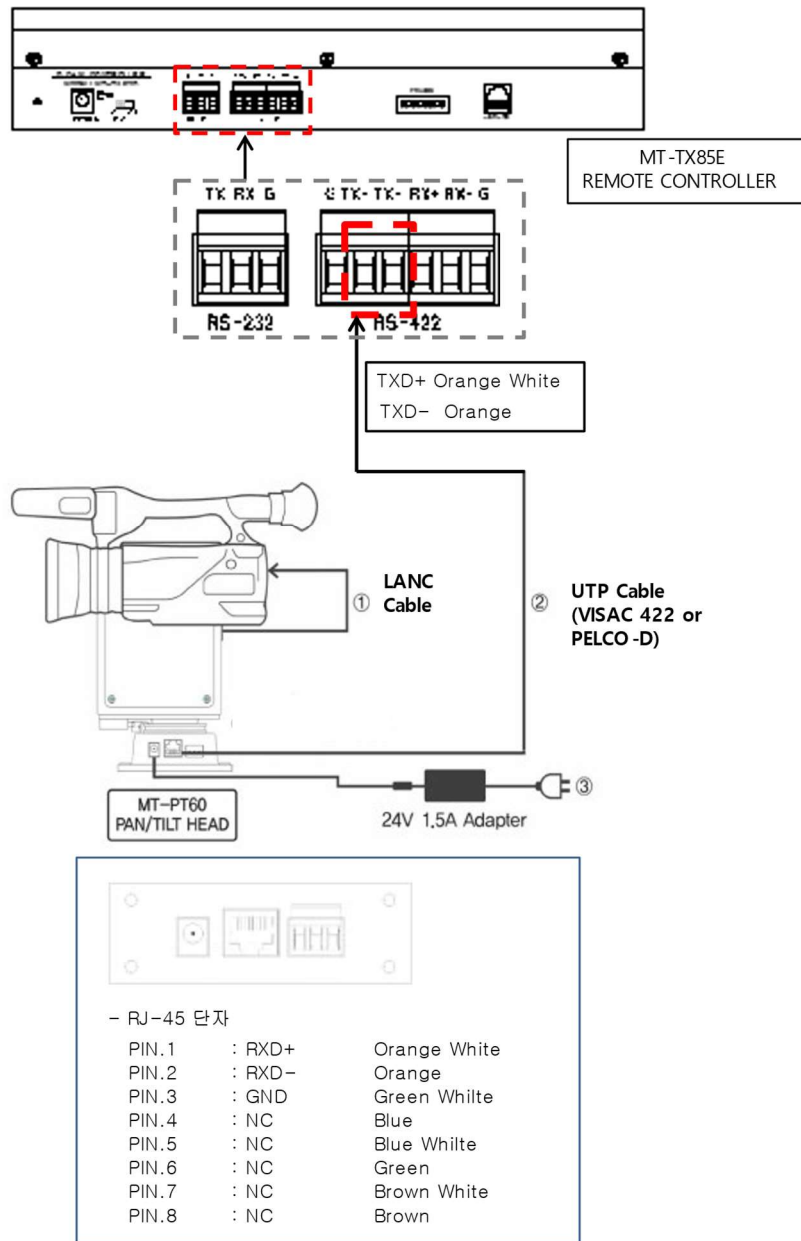

MT-TX90 & MT-PT60 Wiring Diagram

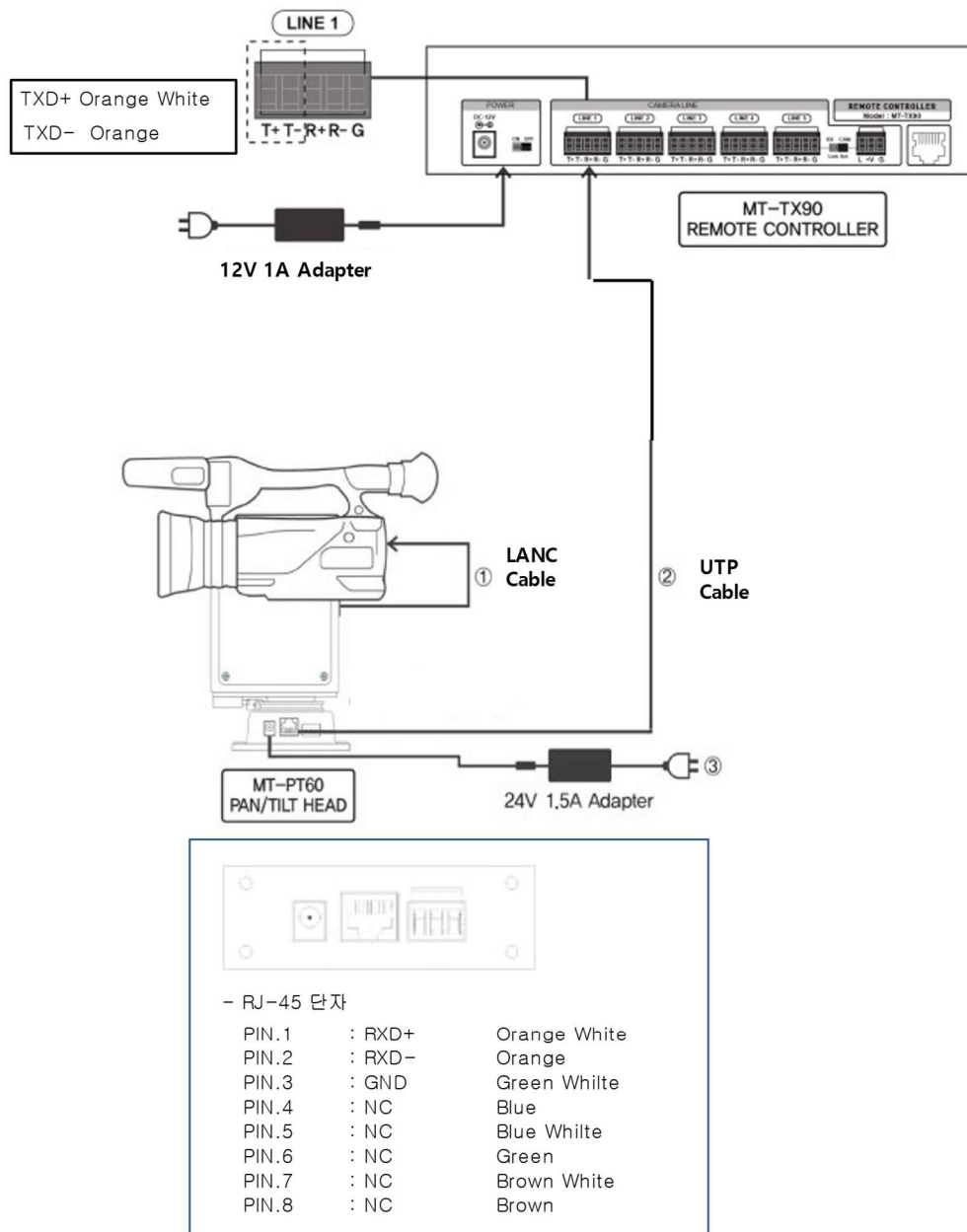

MEMO

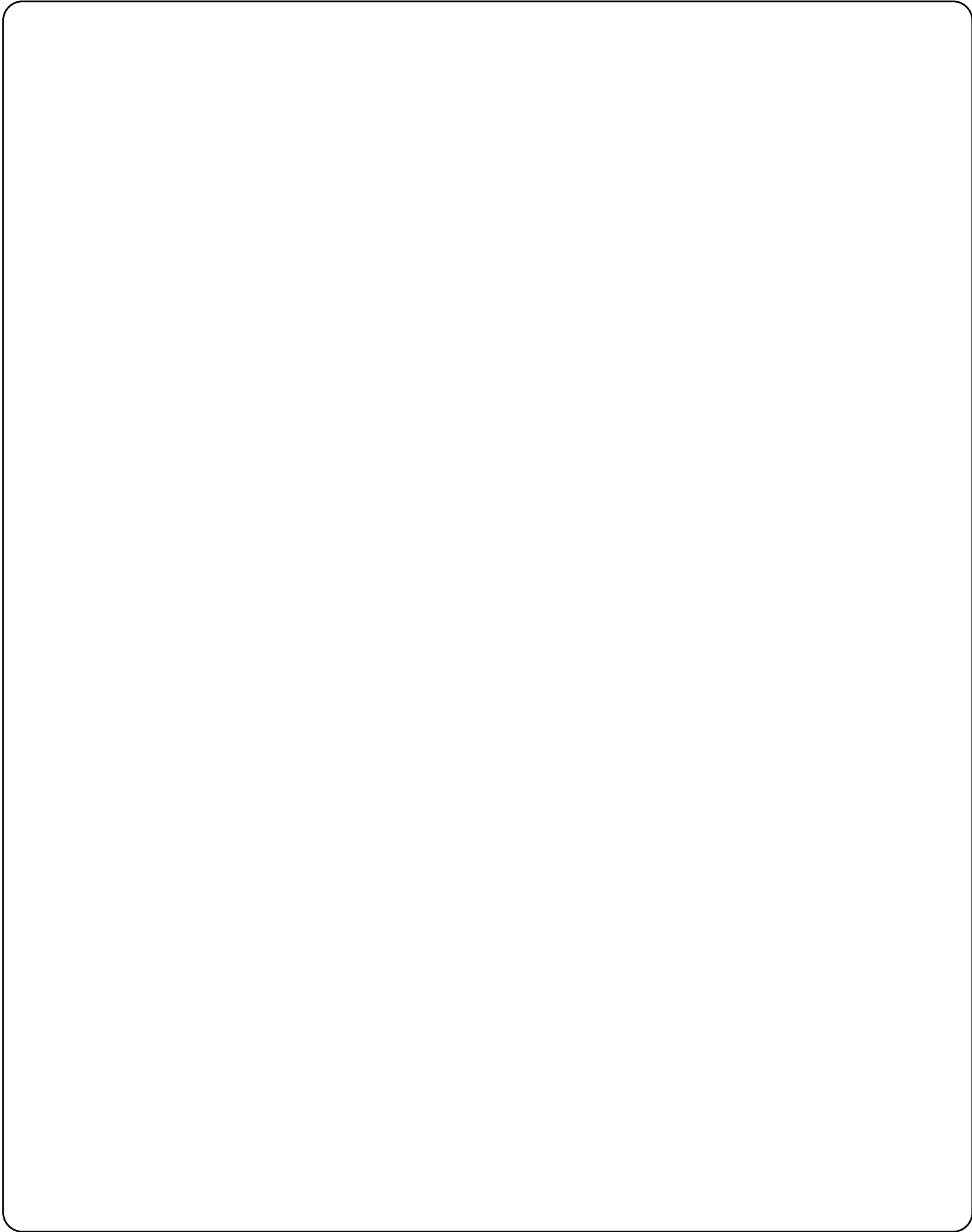

MEMO

A large, empty rectangular box with rounded corners, intended for writing a memo. The box is defined by a thin black border and occupies most of the page's vertical space.

MEMO

A large, empty rectangular box with rounded corners, intended for writing a memo. The box is defined by a thin black border and occupies most of the page below the 'MEMO' header.

MEMO

A large, empty rectangular box with rounded corners, intended for writing a memo. The box is defined by a thin black border and occupies most of the page below the 'MEMO' header.



FOR MORE INFORMATION PLEASE VISIT : <http://www.salrayworks.com>

Unit 905, 1126 Beoman-ro, Geumcheon-gu, Seoul, KOREA

TEL : +82-2-2626-6425, FAX : 82-2-2626-6426, E-mail : anyhelp@salrayworks.com