

Remote Controller

User Manual
Ver 1.14



Contents

| | |
|---|-----------|
| Caution | 4 |
| Introduction & Features | 6 |
| Introduction | 6 |
| Features | 6 |
| System Diagram | 7 |
| Connection of Sharon proSTICK and PTZ using RS-232C | 7 |
| Making RS-232C ⇔ Lan Cable. | 8 |
| RS-422 Connection | 9 |
| - Connection using 9P Connector | 9 |
| RJ-45 Connection (1:N) | 10 |
| - Connection using RJ-45 and 9PConnector | 10 |
| RJ-45 Connection (N:N) | 11 |
| - Connecting 4 Cameras using RJ-45 and 9P Connector | 11 |
| Connect with Sony camera | 12 |
| IP connection | 13 |
| - Connecting NDI cameras using RJ-45 Connector | 13 |
| Controller Basic Setting | 14 |
| IP Setting | 15 |
| Controls & Funtions | 19 |
| White Balance / Auto Exposure Setting | 19 |
| Memory / ACTION Setting | 22 |
| Focus & Zoom mode Settings | 29 |
| Camera Setting | 30 |
| Camera Control | 34 |
| Menu Control | 34 |
| Controller Menu Tree | 35 |
| Controller Menu Setting | 36 |

Dimensions (unit: mm)39

Specifications.....40

Caution



CAUTION

Don't open. There may be electric shock.



<Caution>

To avoid the risk of electric shock, do not arbitrarily open the cover or disassemble the product. There are no user serviceable replacement parts. Get service from qualified service personnel.



This lightning flash with arrowhead symbol is intended to alert the user to the presence of un-insulated "dangerous voltage" within the product's enclosure that may be of sufficient magnitude to constitute a risk of electric shock to person.



This exclamation point symbol is intended to alert the user to the presence of important operating and maintenance (servicing) instructions in the literature accompanying the appliance.

<Caution>

To reduce the risk of fire or electric shock, do not expose this product to rain or moisture.

Important Safeguard

◆ Read the User Manual

Read all of the safety and operating instructions before using the product.

◆ Keep the manual

Please keep the instruction manual for proper use of the product.

◆ Attachments

Do not use attachments or accessories that are not recommended by the manufacturer as they may cause hazards, damage product and void warranty.

◆ Installation Environment

Do not place or mount this product in or on an unstable or improperly supported location. Improperly installed product may fall, causing serious injury to a child or adult, and damage to the product. Use only with a mounting device recommended by the manufacturer, or sold with the product. To insure proper mounting, follow the manufacturer's instructions and use only mounting accessories recommended by manufacturer.

◆ Power

Use the adapter included in the product (DC 12V / 2A).

Precautions

◆ Product Use

- ◆ Before using, make sure power supply and others are properly connected. While operating, if any abnormal condition or malfunction is observed, stop using immediately and then contact your local dealer. (We are not responsible for any problems caused by disassembly or repair of the user.)

◆ Handling

- ◆ Do not disassemble the product and be careful not to touch parts inside the product.
- ◆ Do not drop or subject the product to shock and vibration as this can damage the product.

◆ Installation and Storage

- ◆ Do not install the camera in areas of extreme temperature, which exceed the allowable range. (0 °C~40°C)
- ◆ Avoid installing in humid or dusty places.
- ◆ Avoid installation in a place with radioactivity. It may cause a malfunction of the part.
- ◆ Avoid installation in locations with strong magnetic fields or electrical signals.
- ◆ Avoid installing in places where the product would be subject to strong vibrations.
- ◆ Never expose the camera to rain and water.
- ◆ Unplug the power plug when thundering or lightning strikes. (May cause fire or malfunction.)

Introduction & Features

Introduction

This product is a camera controller that is composed of 50 function keys, 4 knobs, 3 axes joystick, and LCD display, which is designed to directly control equipment such as conference camera and PTZ camera.

Features

1. Up to 14 Pan / Tilt / Zoom cameras can be controlled.
 2. Two way remote control is supported by using RS-232C and RS-422 communication, and camera operation status can be checked through buttons and LCD.
 3. Supports VISCA protocol.
- * Compatible with SONY cameras.
- Compatible models: EVI-D30/31, EVI-D70/P, EVI-HD1, EVI-H100V, EVI-H100S, BRC-300/P, BRC-H700, BRC-Z700, BRC-H900, BRC-Z330, SRG-300H
4. Available communication speeds are 9600bps and 38400bps.
 5. Two-way communication is available via IP communication, and you can confirm the status of the camera by monitoring button and LCD screen.
 6. This remote controller support VISCA over IP protocol.
 7. You can use the joystick and speed button to control the Pan /Tilt speed of the camera.
 8. Fine adjustment is available. (Pan: 24 levels, Tilt: 23 levels, Zoom: 16 levels).
 9. 4 Line Text LCD is used to check and input the menu control operation status.
 10. You can easily operate Preset, Pattern, Swing and Group functions by using Function key.
 11. By adopting a three-color LED, you can intuitively check the operation status of the camera.
 12. This remote controller supports 'POE+' only (not 'POE').

System Diagram

Connection of SHARON proSTICK and PTZ using RS-232C

Press and hold the MENU button at the bottom of the LCD window (the MENU button will blink). In the LCD window, select the Baud rate 9600 and Interface RS-232C using the joystick and press the EXIT button to exit the setting.

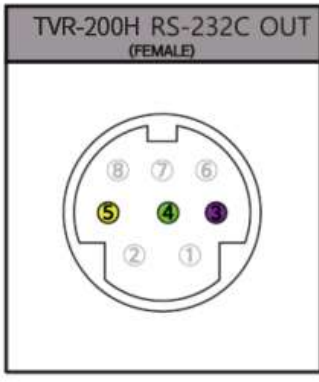
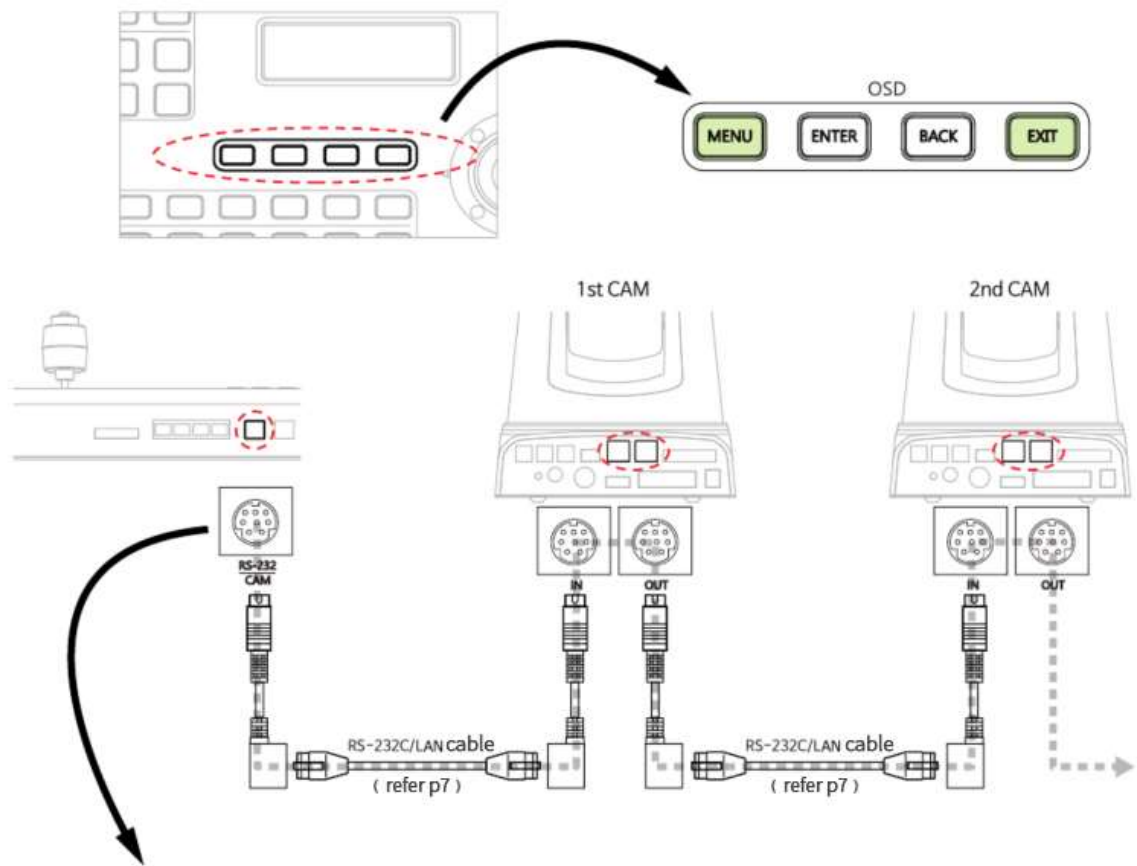

| CAM RS-232C IN (FEMALE) | |
|-------------------------|--------|
| 1 | DTR IN |
| 2 | DSR IN |
| 3 | TX |
| 4 | GND |
| 5 | RX |
| 6 | GND |
| 7 | N.C |
| 8 | N.C |

| CAM RS-232C OUT (FEMALE) | |
|--------------------------|---------|
| 1 | DTR OUT |
| 2 | DSR OUT |
| 3 | TX |
| 4 | GND |
| 5 | RX |
| 6 | GND |
| 7 | N.C |
| 8 | N.C |



Making RS-232C ⇔ Lan Cable.



This is different from normal/general network

* If you only want to connect the camera using the Network Direct cable, it is convenient to use the optional KTM-100.

1) Configuration of camera and camera control cable using 2 LAN cables

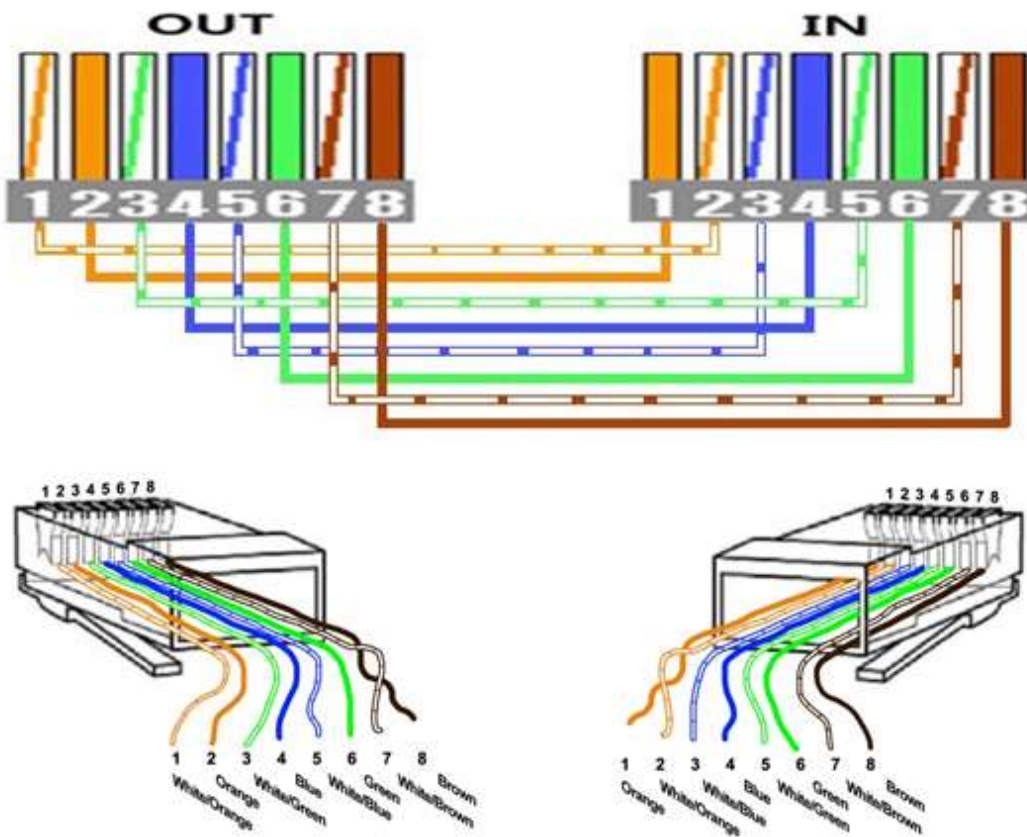

2) Configuration of camera and camera control cable using 1 LAN cable divided into 4 wires

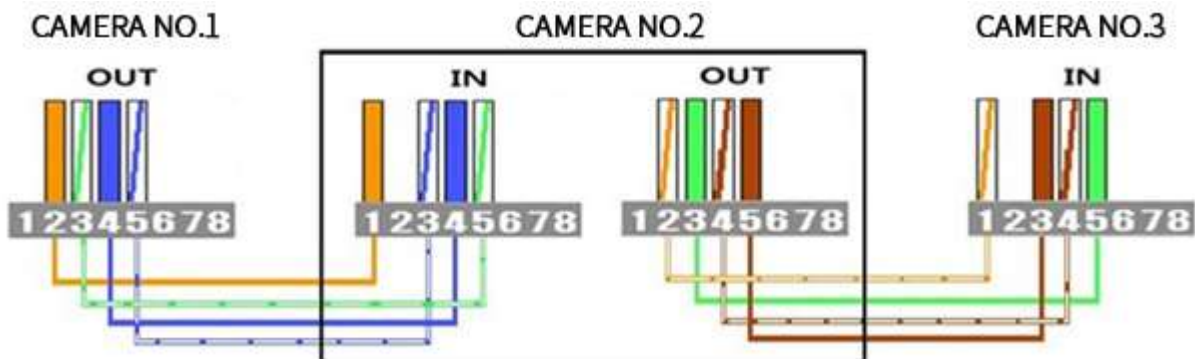

RS-422 Connection

- Connection using 9P Connector

● SHARON PTZ Series Connection

Press and hold the MENU button at the bottom of the LCD window (the MENU button will blink). In the LCD window, select the Baudrate and Interface RS-422 using the joystick and press the EXIT button to exit the setting.

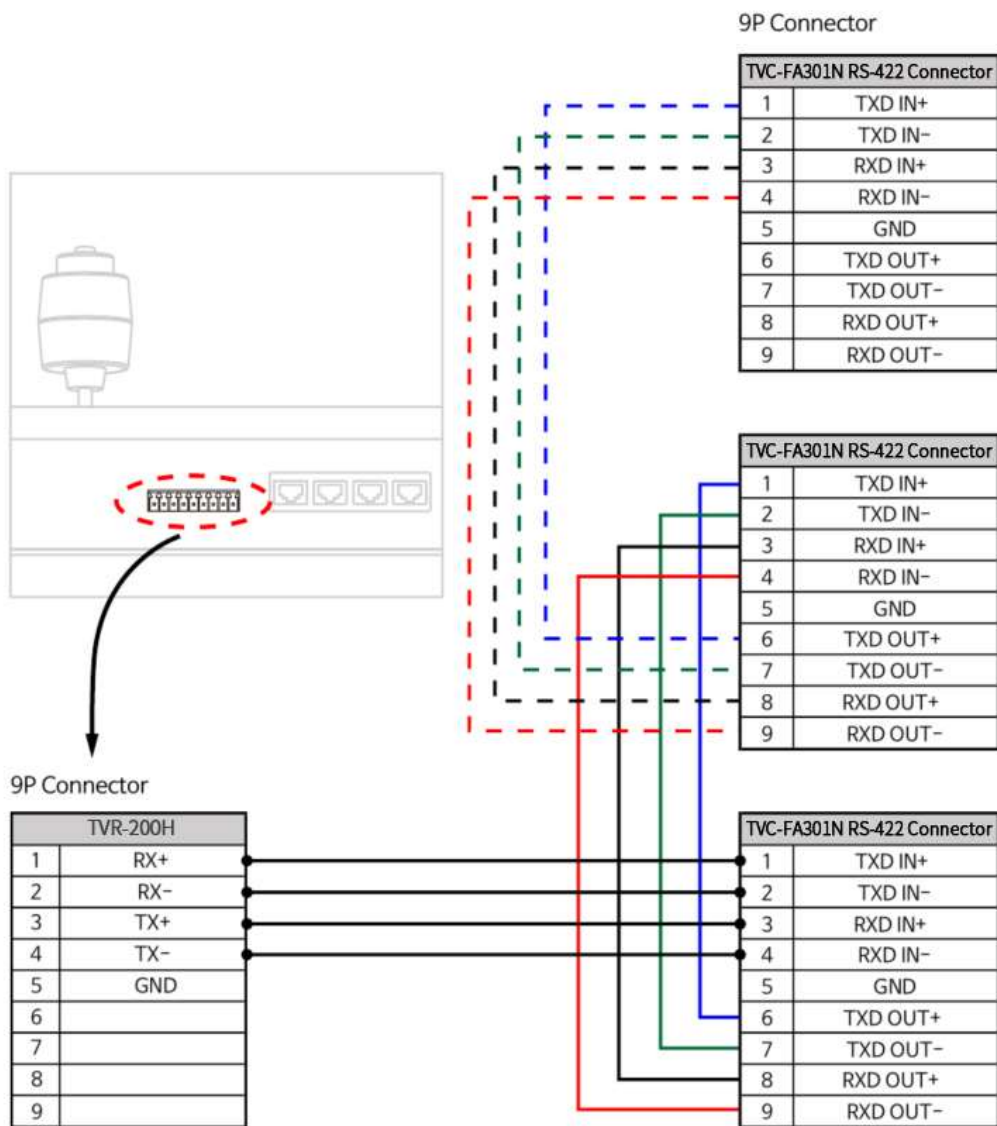

RJ-45 Connection (1:N)

- Connection using RJ-45 and 9P Connector

1. Check Point : a) Camera Mech F/W ver : Over 2.00 b) Additional Camera Type B Check
2. Camera Bottom DIP_SW No. 5 ON
3. The connection should be configured as shown below.

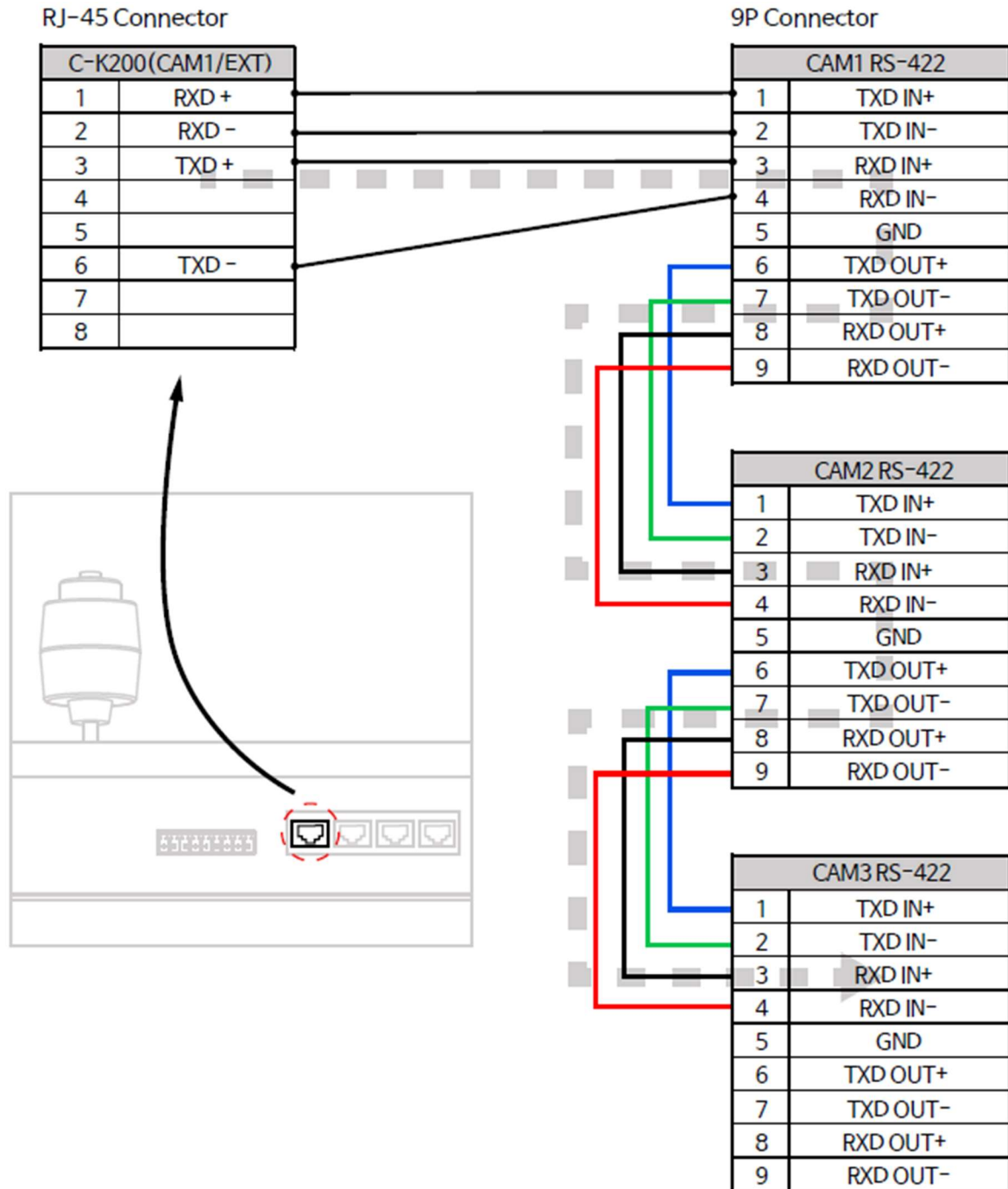

RJ-45 Connection (N:N)

- Connecting 4 Cameras using RJ-45 and 9P Connector

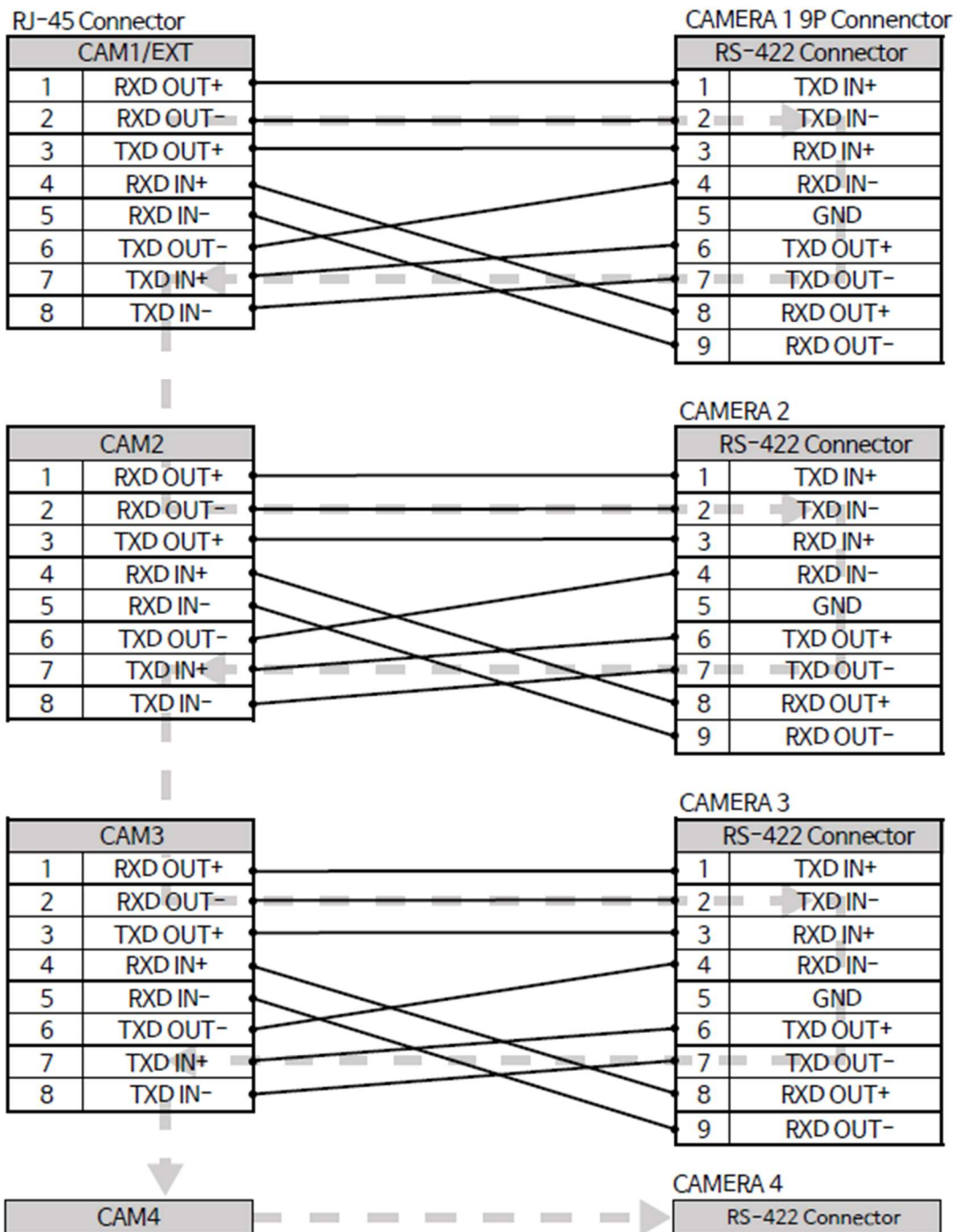
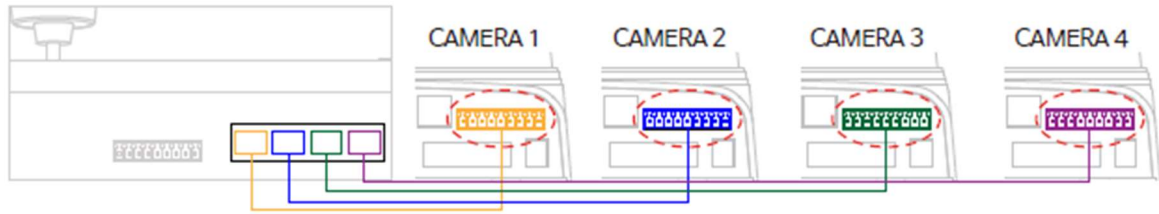

Connect with Sony camera

- BRC-300 RS-422 Connection

Press and hold the MENU button at the bottom of the LCD window (the MENU button will blink). In the LCD window, select the Baudrate and Interface RS-422 using the joystick and press the EXIT button to exit the setting.

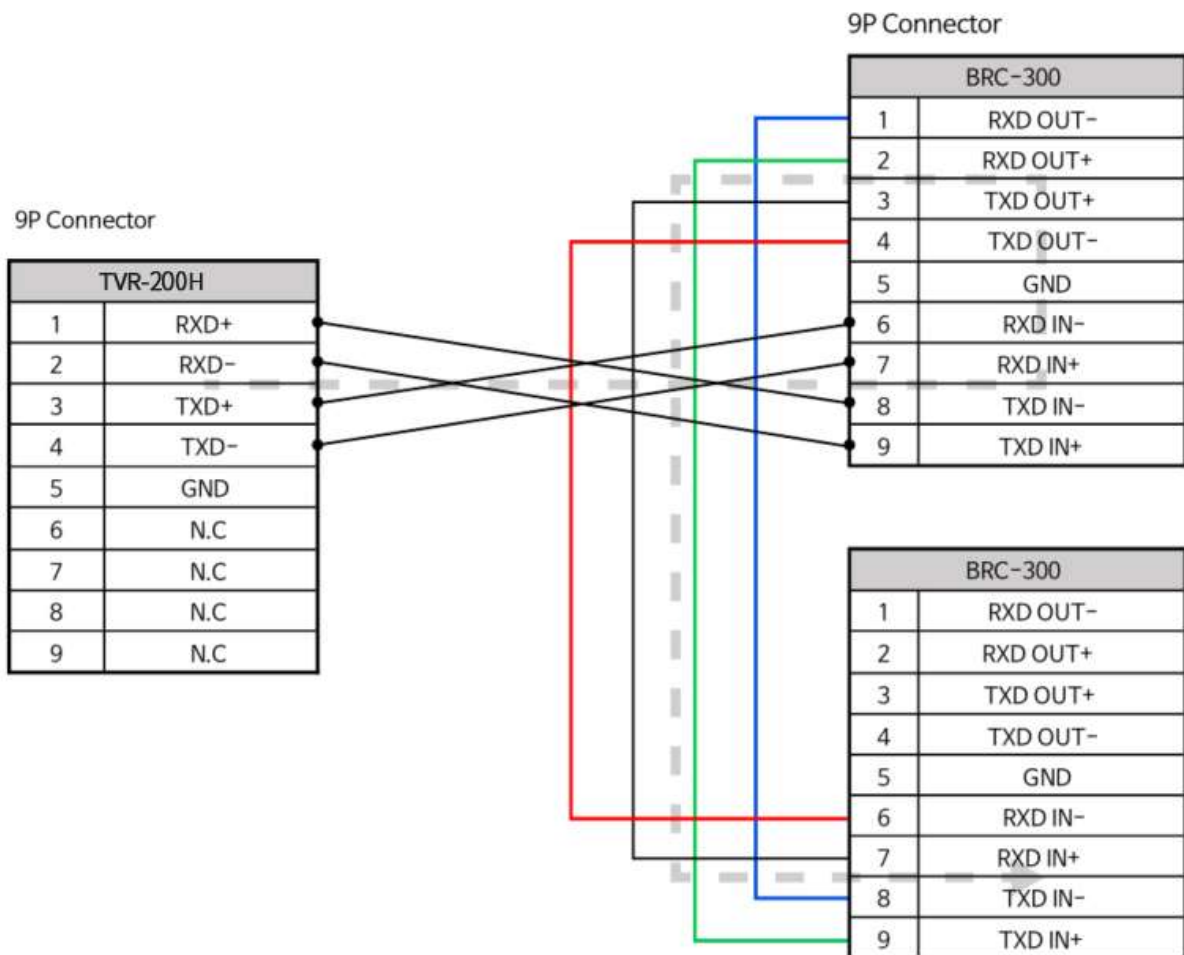

■ IP connection

- Connecting NDI cameras / Motorized Head using RJ-45 Connector

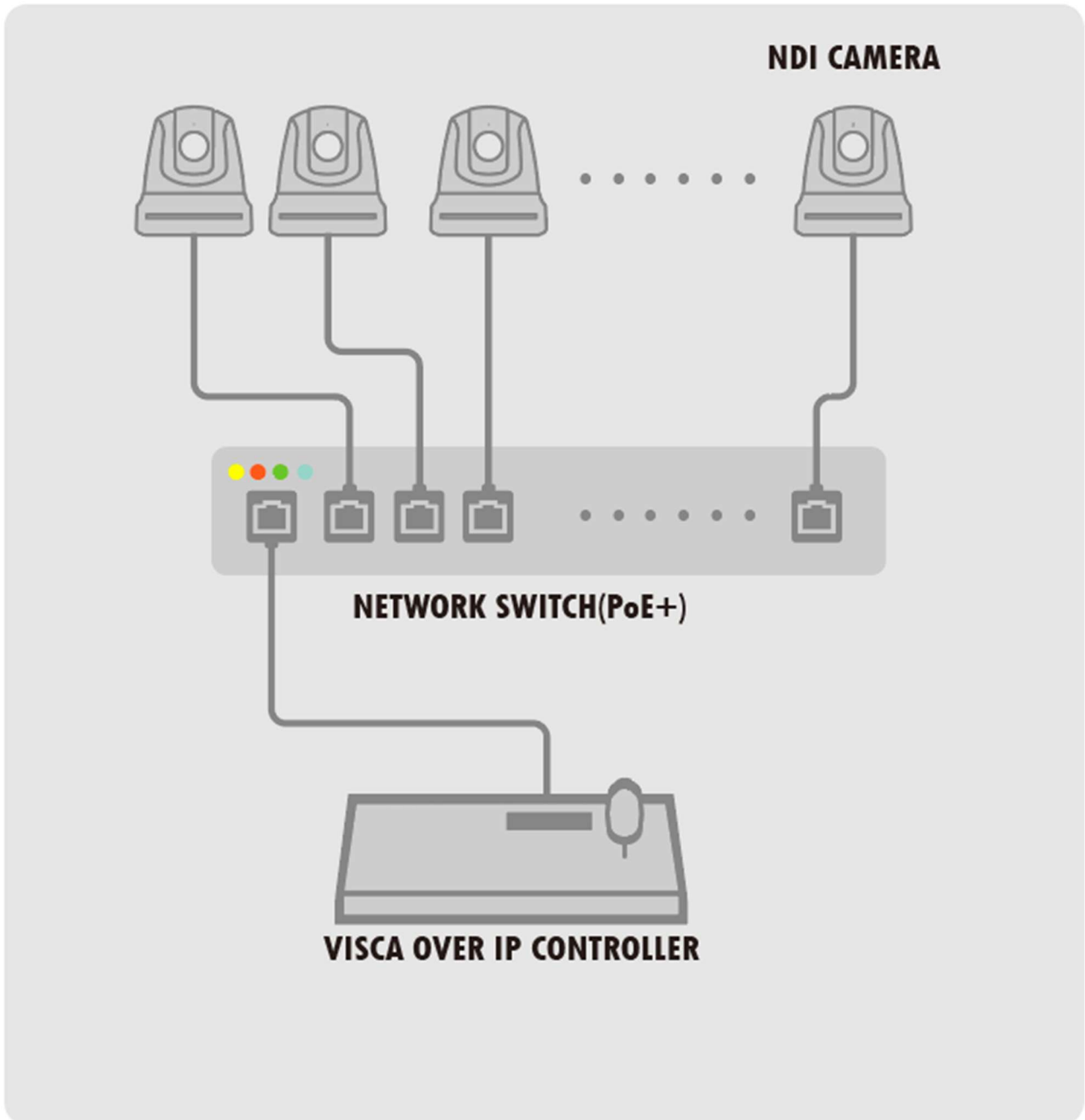

Controller Basic Setting

- Keep pressing the MENU button for 3 seconds to enter the Controller Setup menu.
- You can confirm the status by checking the LCD screen.
- Use the joystick to move within the menu.

```
S y s t e m   S e t u p   # 1
→ P r o t o c o l       : V I S C A   I P
   I n t e r f a c e     S t a t i c
< I P   S e t t i n g >
```

```
S y s t e M   S e t u p   # 1
→ P r o t o c o l       : V I S C A
   B a u d r a t e       3 8 4 0 0 b p s
   I n t e r f a c e     R S - 4 2 2
```

1) Protocol

- When 'protocol' is set to 'VISCA IP' or 'SONY IP', you can control via 'VISCA Over IP'
- When 'Protocol' is set to 'VISCA', you can communicate via RS-232 or RS-422

2) Interface

- When 'protocol' is set to 'VISCA IP' or 'SONY IP', You can select '**DHCP**' for automatic I.P set-up, and '**STATIC**' for manual IP set-up'
- When 'protocol' is set to 'VISCA', you can select the interface (RS-232 or RS-422) and the Baud Rate (9600bps or 38400bps).

3) IP Set-up

- When 'protocol' is set to 'VISCA IP' or 'SONY IP', go into detail IP setup for VISCA Over IP operation. (For more information, go to next page - 'IP Setup' section)

4) Jog Sensitivity

- Sets the sensitivity of the first movement in the center of the joystick.
- Sensitivity can be set from 1 to 8, which is the most sensitive when set to 1, and the least sensitive when set to 8.

5) Pan Direction

- Changes the camera's Pan direction. When it is Normal, the operation direction of the joystick matches the operation direction of the camera. When is Inverse, the operation direction of the camera changes

in the opposite direction of the joystick.

6) Backlight

- Change the LCD backlight maintain time.
- When set to On, backlight is always maintained. When it is set to Off, backlight is always Off.

7) Buzzer

- Used to activate/ deactivate the Buzzer.
- Buzzer is a function that notifies the user by sound when the menu is On and Off or when the operation exceeds the operation range of the controller.

- **Start the adjustment after all connected cameras have completed self-diagnosis.**

IP Setting

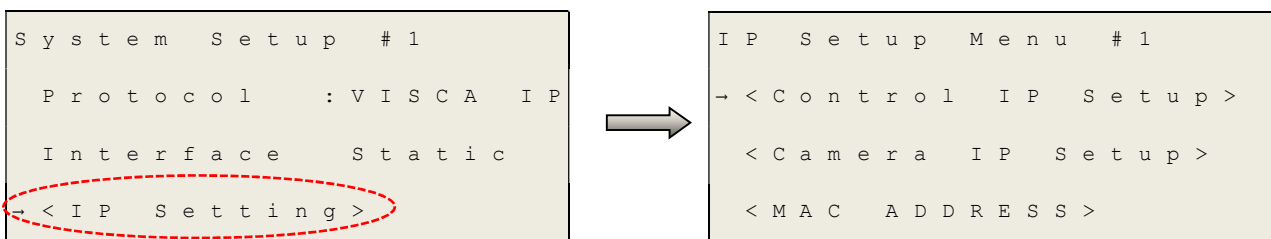

1) Control IP Setup

- Used for setting up the IP and Port of the controller

2) Camera IP Setup

- Used for setting up the IP, Port and CAM number of the camera

3) MAC ADDRESS

- Enter to confirm the Mac Address of the controller

Ⓐ How to set up Controller IP and Port

- Enter Sub-Menu to input IP address by using number keys in the Memory/Action part on the controller.
- Same way to input values in NM and GW.

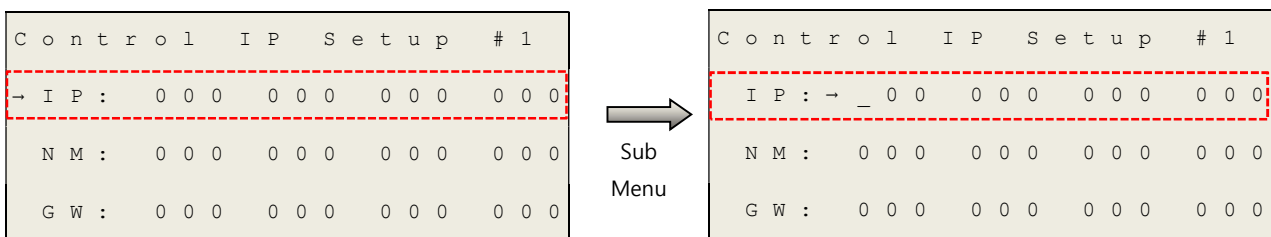

Example) How to input IP address of 192.168.0.10.

- Press 1, 9 and 2 keys in order.

(If the value is '0', please make sure to input '0' on number key pad)

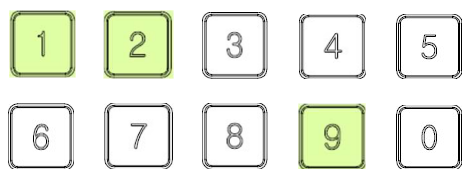

```
C o n t r o l   I P   S e t u p   # 1
IP : -> 1 9 2   _ 0 0   0 0 0   0 0 0
NM :   0 0 0   0 0 0   0 0 0   0 0 0
GW :   0 0 0   0 0 0   0 0 0   0 0 0
```

- Press 1, 6 and 8 keys in order.

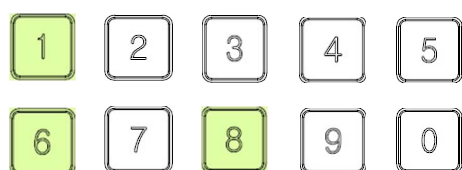

```
C o n t r o l   I P   S e t u p   # 1
IP : -> 1 9 2   1 6 8   _ 0 0   0 0 0
NM :   0 0 0   0 0 0   0 0 0   0 0 0
GW :   0 0 0   0 0 0   0 0 0   0 0 0
```

- Press 0, 0 and 0 keys in order.

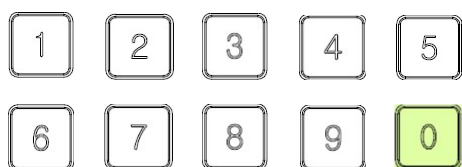

```
C o n t r o l   I P   S e t u p   # 1
IP : -> 1 9 2   1 6 8   0 0 0   _ 0 0
NM :   0 0 0   0 0 0   0 0 0   0 0 0
GW :   0 0 0   0 0 0   0 0 0   0 0 0
```

- Press 0, 1 and 0 keys in order.

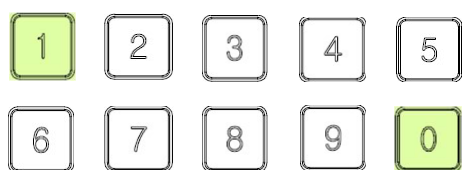

```
C o n t r o l   I P   S e t u p   # 1
IP : -> 1 9 2   0 0 0   0 0 0   0 1 0
NM :   0 0 0   0 0 0   0 0 0   0 0 0
GW :   0 0 0   0 0 0   0 0 0   0 0 0
```

- Enter Sub Menu to input the 'Port' numbers.

```
C o n t r o l   I P   S e t u p   # 2
-> P o r t :   4 9 1 5 3
C O N F I R M           N o
```



Sub
Menu

```
C o n t r o l   I P   S e t u p   # 2
P o r t : -> _ 9 1 5 3
C O N F I R M           N o
```



Example) How to input Port of 49153.

- Press 4, 9, 1, 5 and 3 keys in order.

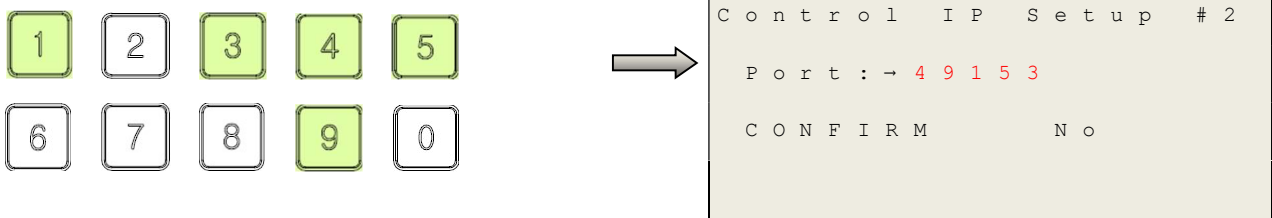
(If the value is '0', please make sure to input '0' on number key pad)

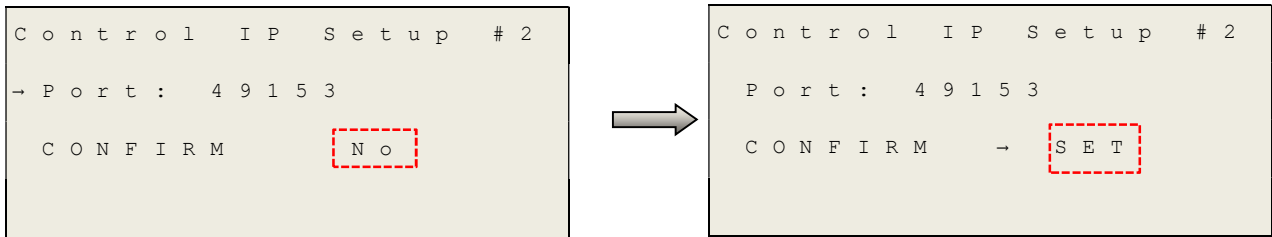

- If you select 'SET' in the CONFIRM menu, then the same values are applied.



ⓑ How to set up Camera IP and Port

- Enter Sub Menu to input IP and Port value by using the number keys in Memory/Action part of the controller

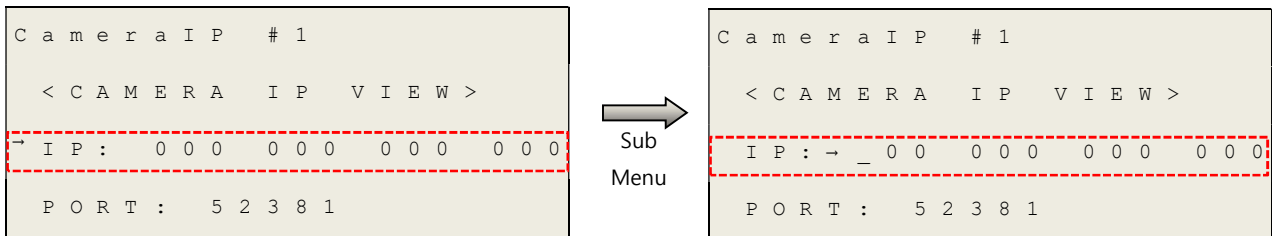

Example) How to input IP address of 192.168.0.10

- Press 1, 9 and 2 keys in order.

- (If the value is '0', please make sure to input '0' on number key pad)

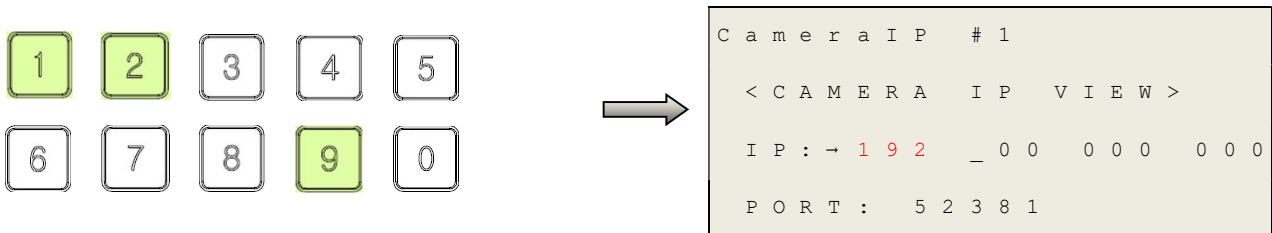

- Press 1, 6 and 8 keys in order.

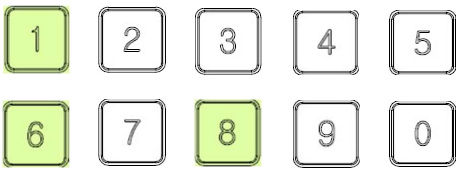

```
C a m e r a I P # 1
< C A M E R A I P V I E W >
I P : -> 1 9 2 1 6 8 _ 0 0 0 0 0
P O R T : 5 2 3 8 1
```

- Press 0, 0 and 0 keys in order.

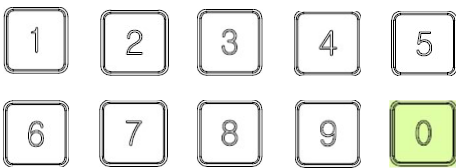

```
C a m e r a I P # 1
< C A M E R A I P V I E W >
I P : -> 1 9 2 1 6 8 0 0 0 _ 0 0
P O R T : 5 2 3 8 1
```

- Press 0, 1 and 0 keys in order.

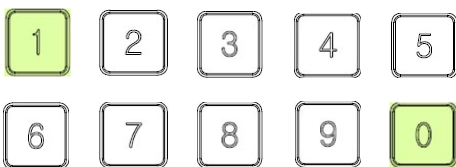

```
C a m e r a I P # 1
< C A M E R A I P V I E W >
I P : -> 1 9 2 1 6 8 0 0 0 0 1 0
P O R T : 5 2 3 8 1
```

- Enter Sub Menu to input Port number by using the number keys in Memory/Action part of the controller

```
C a m e r a I P # 1
< C A M E R A I P V I E W >
I P : 1 9 2 1 6 8 0 0 0 0 1 0
-> P O R T : 5 2 3 8 1
```



```
C a m e r a I P # 1
< C A M E R A I P V I E W >
I P : 1 9 2 1 6 8 0 0 0 0 1 0
P O R T : -> _ 2 3 8 1
```

Example) How to input Port number of 52381.

- Press 5, 2, 3, 8 and 1 keys in order.

- (If the value is '0', please make sure to input '0' on number key pad)

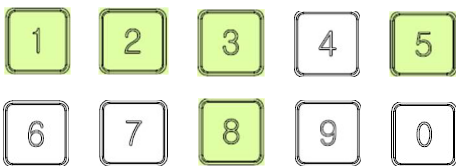

```
C a m e r a I P # 1
< C A M E R A I P V I E W >
I P : 1 9 2 1 6 8 0 0 0 0 1 0
P O R T : -> 5 2 3 8 1
```

- Enter Sub Menu to store the desired IP and Port values to a desired CAM number.

```
C a m e r a I P # 2  
→ C A M I D : C A M 1
```

```
C a m e r a I P # 2  
C A M I D : → C A M 1
```

Controls & Functions

White Balance / Auto Exposure Setting

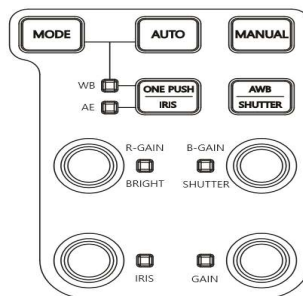

1) MODE



- Used to set the mode for white balance and auto exposure.
- In white balance mode, WB indicator lights up in green.
- In auto exposure mode, the AE indicator lights up in red.
- Pressing the MODE button repeatedly changes the white balance mode and auto exposure mode repeatedly, allowing you to set the desired setting.

2) AUTO



Used to set the selected white balance or auto exposure to AUTO.

3) MANUAL



Used to set the selected white balance or auto exposure to MANUAL using the knob.

4) ONE PUSH / IRIS



- ONE PUSH is set for white balance mode, and the white balance function is activated by pressing the right AWB button (blinks for 3 seconds and lights up).



- In auto exposure mode, it is set to IRIS priority.

5) AWB / SHUTTER



- AWB is operated when the white balance mode is ONE PUSH.

- In auto exposure mode, it is set to SHUTTER priority.



6) R-GAIN/ BRIGHT



```
CAM1 PRESET:250-255
WB:ManuaL PS:360/s
AE:Shutter PT:8var
R-Gain Up ZS:8var
```

```
CAM1 PRESET:250-255
WB:ManuaL PS:360/s
AE:Shutter PT:8var
Bright Up ZS:8var
```

- When the white balance is set to MANUAL, the indicator lights up in green and the R-GAIN value changes.
- When auto exposure is set to Bright, the indicator lights up in red and the Bright value changes. (Set in the camera menu.)
- The changed setting can be checked on the LCD.

7) B-GAIN/ SHUTTER



```
CAM1 PRESET:250-255
WB:ManuaL PS:360/s
AE:Iris PT:8var
B-Gain Up ZS:8var
```

```
CAM1 PRESET:250-255
WB:ManuaL PS:360/s
AE:Iris PT:8var
Shutter+ ZS:8var
```

- When the white balance is set to MANUAL, the indicator lights up in green and the B-GAIN value changes.
- When auto exposure is set to MANUAL or SHUTTER, the indicator lights up in red and the Shutter speed changes.
- The changed setting can be checked on the LCD.

8) IRIS



```
CAM1 PRESET:250-255
WB:ManuaL PS:360/s
AE:Iris PT:8var
Iris Up ZS:8var
```

- Activates only when the auto exposure is set in MODE.
- When auto exposure is set to MANUAL or IRIS priority, the indicator lights up in red and the Iris value changes.
- The changed setting can be checked on the LCD.

9) GAIN



```
CAM1    PRESET: 250-255  
WB: Manual    PS: 360 / s  
AE: Iris      PT: 8 var  
Gain Up    ZS: 8 var
```

- Activates only when the auto exposure is set in MODE.
- When auto exposure is set to IRIS priority, the indicator lights up in red and the Gain Limit value changes.
- When auto exposure is set to MANUAL, the indicator lights up in red and the Gain value changes

Memory / ACTION Setting

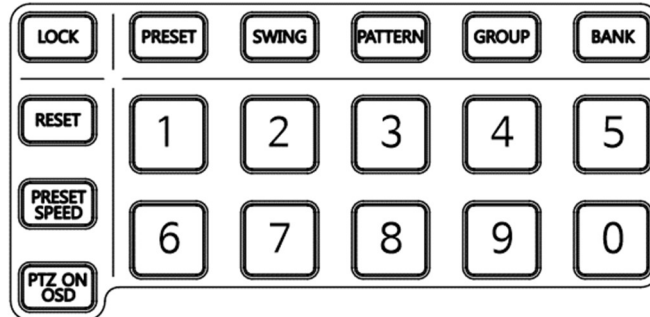

1) LOCK

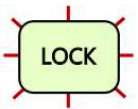

- Used to prevent the camera of the selected ID from operating.
- When the LOCK button is selected, all functions except camera ID selection are restricted.
- The buzzer sounds once to announce the start of the LOCK function.

- The LOCK button flashes to indicate that the LOCK function is being activated.

2) PRESET



- Used to move to preset point.

- The number of presets is set differently depending on the connected camera. (255 for KE Series)

- Confirm that the PRESET button is lit to set, activate, or delete a preset.

- If it is not lit, press PRESET button to change to PRESET mode.

- Pressing the PRESET button will illuminate the number buttons that can be set, activated and deleted, and then turn off after 5 seconds.

- The figure below shows No. 250 preset bank in Bank function and shows the lighting status of number button which can select preset from 250 ~ 255 when PRESET button is pressed.

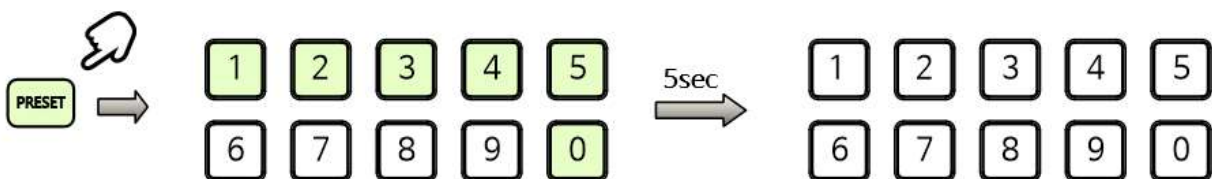

- When using Preset function, refer to Page 21 'BANK function'.

Preset Setup (PRESET + Number)

- ① Use the joystick to move to the desired position and set the shooting conditions such as white balance and auto exposure.
- ② Press the number button on the bottom while holding the PRESET button.
- The preset status can be checked on the LCD.

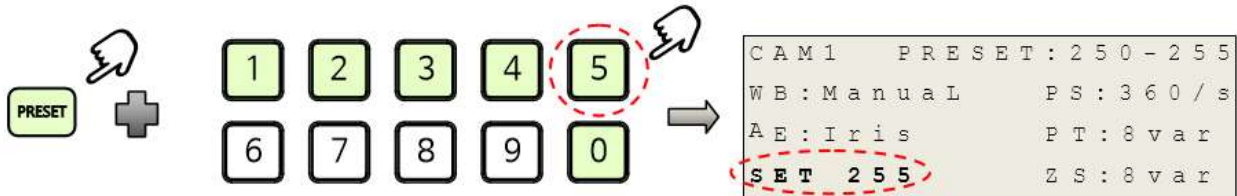

Preset Activation

- ① Press the preset number button.
- The moved preset status can be checked on the LCD.

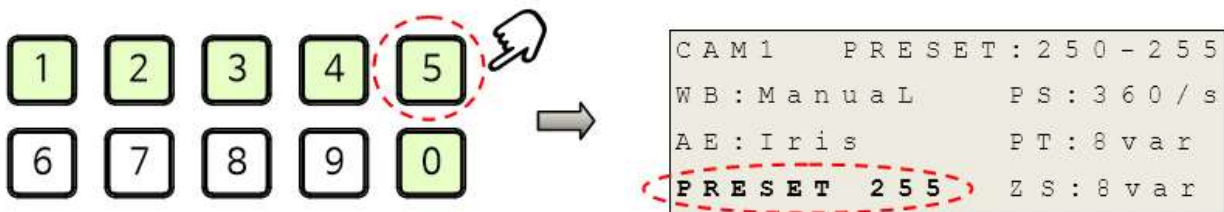

Preset Deletion (RESET + Number)

- ① Press the preset number button while holding the PRESET button.
- The deleted preset status can be checked on the LCD.

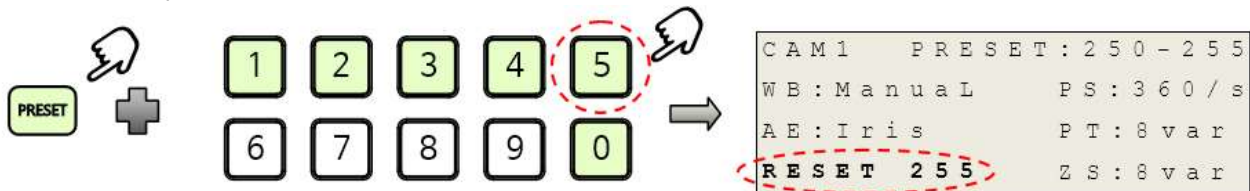

3) PRESET SPEED

- PRESET SPEED** - Used to set the preset speed.
- PRESET SPEED** - The movement speed of preset can be set from 5° / sec to 360° / sec. and can be set in 10 steps.

* If you want precise adjustment, change the Preset Speed value in the camera MENU(OSD) screen.

- Pressing the PRESET button will light the currently set preset speed number button.
- The currently set preset speed status can be checked on the LCD.

Preset Speed Check

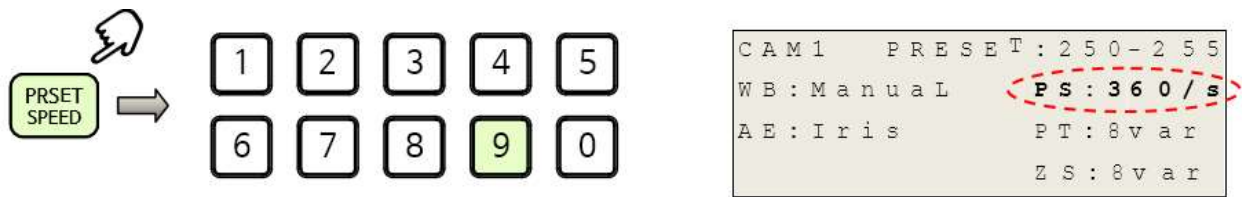

Preset Speed Setup (PRESET SPEED + Number)

- ③ While holding the PRESET SPEED button, press the preset speed number button.
- Preset speed status can be checked on the LCD.

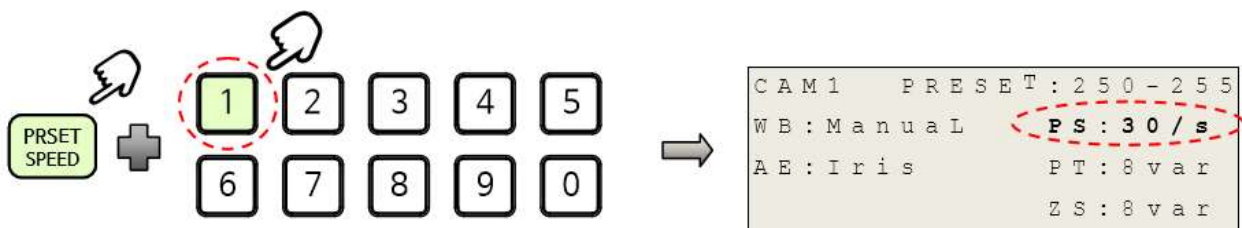

4) SWING

SWING

- Moves back and forth between two preset positions.
- The number of Swings depends on the connected camera. (8 for KE series)
- The Swing number that can be set, activated and deleted is displayed on the LCD.

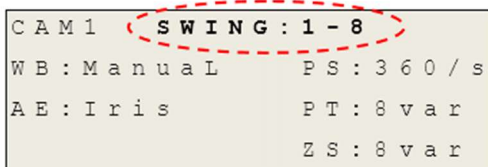

For example, in case of SWING: 1-8, pressing the '1' number button will activate swing number 1. If the '5' number button is pressed, swing number 5 will be activated.

- Make sure that the SWING button is lit to set, activate, or delete the Swing.
- Pressing the SWING button turns on the swing number buttons that can be set, activated and deleted, and turns off after 5 seconds.

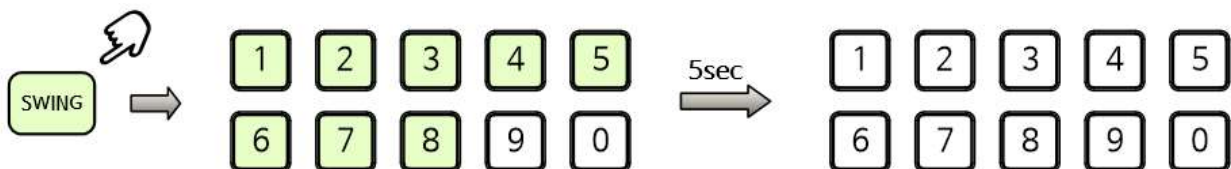

Swing Setup (SWING + Number)

- ③ While holding the SWING button, press the number button that you want to set.
- ④ Check that two preset points are set.
- Swing setup status can be checked on the LCD.

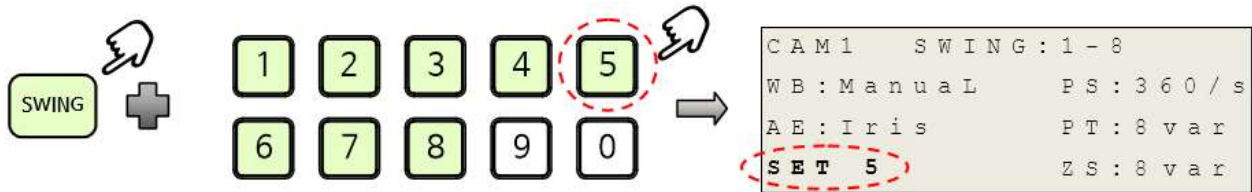

Swing Activation

- ③ Press the swing number button.
- Swing status can be checked on the LCD.

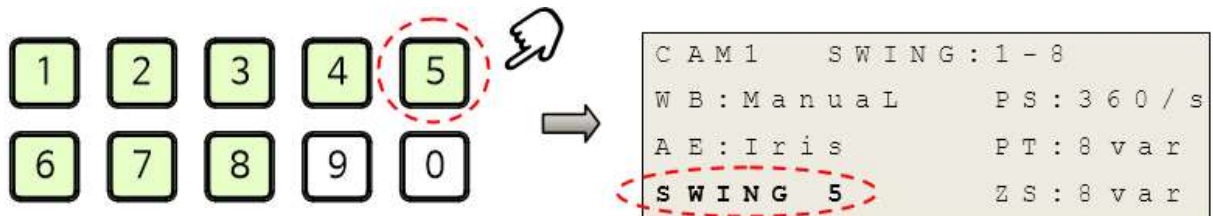

Swing Deletion (RESET+ Number)

- ③ Hold the RESET button and press the swing number button.
- The deleted swing status can be checked on the LCD.

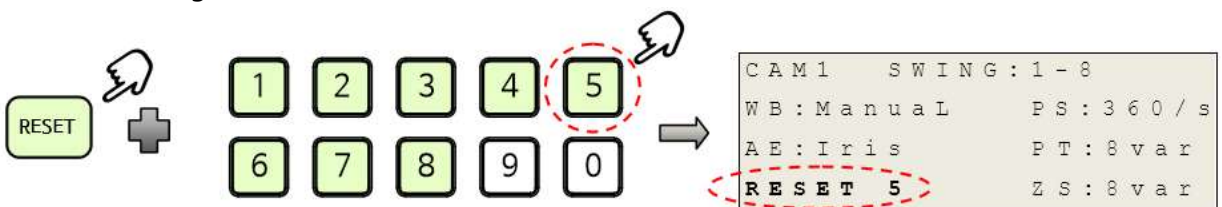

5) PATTERN



- The jog operation, preset, and swing operation performed for a certain period of time are saved and activated again.
 - The Pattern number that can be set, activated and deleted is displayed on the LCD. (8 for KE series)
- For example, in case of PATTERN: 1-8, pressing the '1' number button will activate pattern number 1. If the '5' number button is pressed, pattern number 5 will be activated.

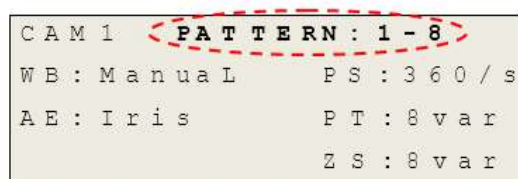

- Make sure that the PATTERN button is lit to set, activate, or delete the Pattern.
- Pressing the PATTERN button turns on the pattern number buttons that can be set, activated and deleted, and turns off after 5 seconds.

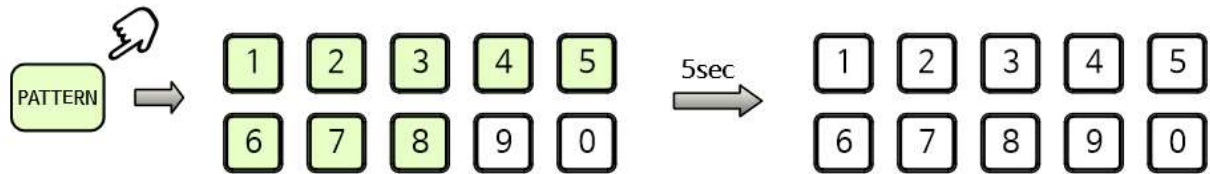

Pattern Setup (PATTERN + Number)

- ① While holding the PATTERN button, press the number button that you want to set.
- The set Pattern status can be checked on the LCD.

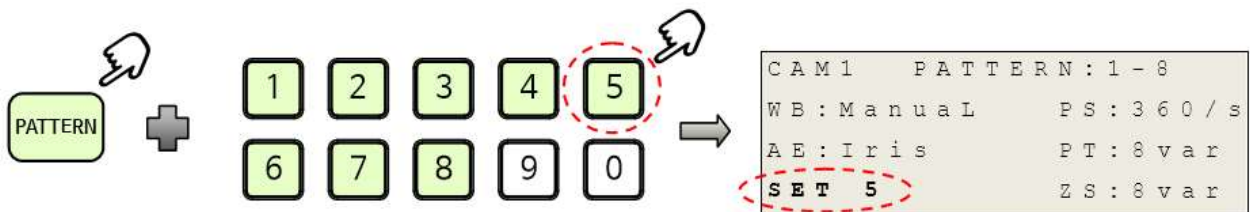

Pattern Activation

- ① Press the pattern number button.
- The activated Pattern status can be checked on the LCD.

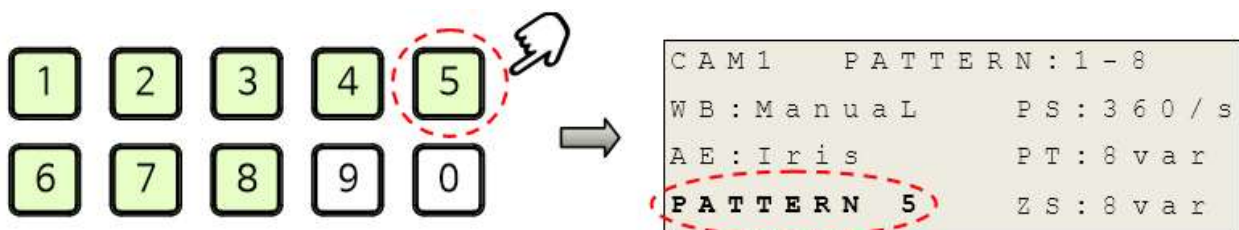

Pattern Deletion (RESET+ Number)

- ① Hold the RESET button and press the pattern number button.
- The deleted pattern status can be checked on the LCD.

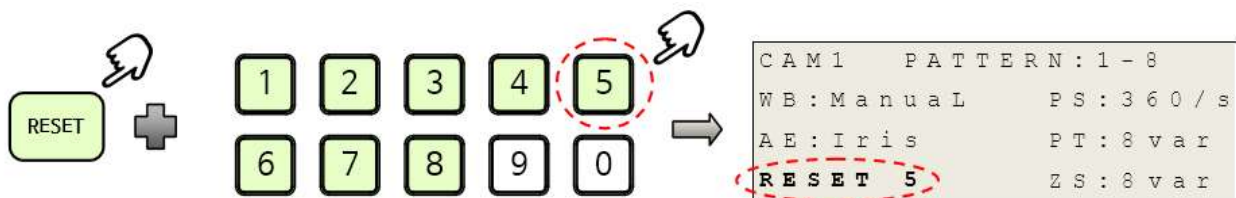

6) GROUP

GROUP

- Sets the sequence of preset, swing, and pattern to be activated sequentially.

- The Group number that can be set, activated and deleted is displayed on the LCD. (8 for KE series)

```
CAM1  GROUP: 1 - 8
WB: Manual  PS: 360 / s
AE: Iris    PT: 8 var
           ZS: 8   Z: 8
```

For example, in case of GROUP 1-8, pressing the '1' number button will activate group number 1. If the '5' number button is pressed, group number 5 will be activated.

- Make sure that the GROUP button is lit to set, activate, or delete the Group.

- Pressing the GROUP button turns on the group number buttons that can be set, activated and deleted, and turns off after 5 seconds.

Group Setup (GROUP + Number)

① While holding the GROUP button, press the number button that you want to set.

- The set Group status can be checked on the LCD.

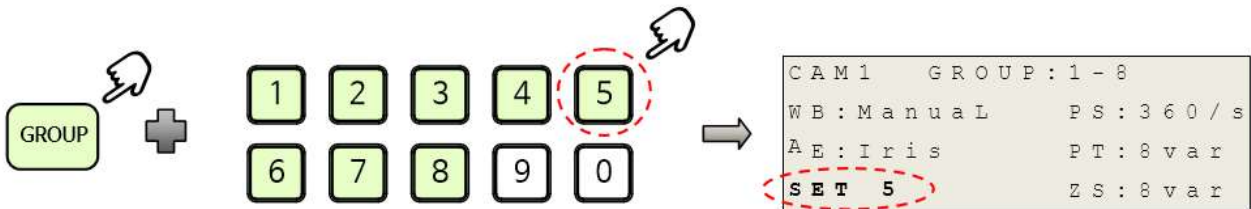

Group Activation

① Press the group number button.

- The activated Group status can be checked on the LCD.

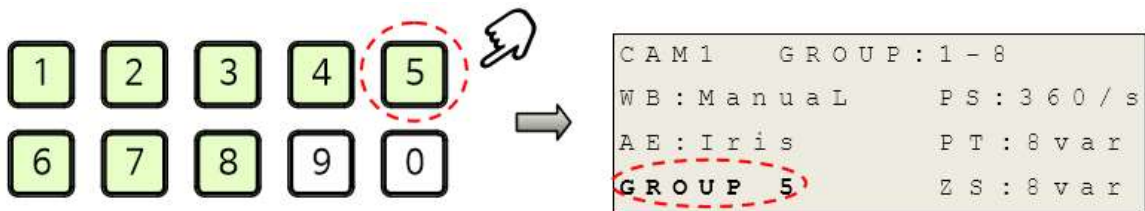

Group Deletion (RESET+ Number)

① Hold the RESET button and press the group number button.

- The deleted group status can be checked on the LCD.

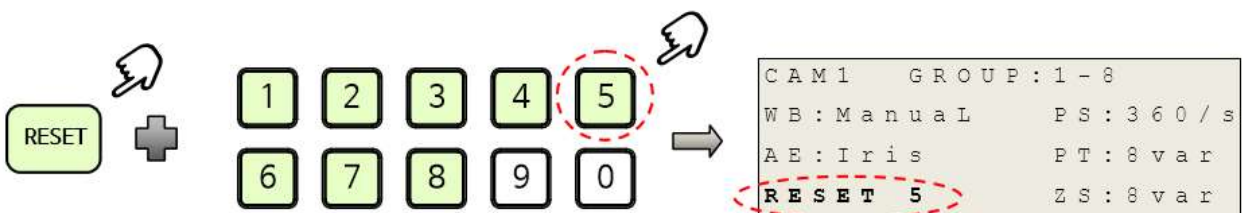

7) BANK



- Used to quickly set, move, activate and delete the preset function by using 1 ~ 0 number buttons in 10 units.

- For example, if you frequently use presets from 120 to 129, set the BANK to 120 and use the 0 ~ 9 buttons to move to a preset position between 120 ~ 129.

- The setting range of the BANK is set differently according to the preset storage capacity of the connected camera. (In case of KE series, 255 presets can be saved.)

Bank Setup

Ⓐ Check that the PRESET button is lit.

Ⓑ Press the BANK button. When the BANK button and the number buttons blink, it is a settable mode.

- The BANK setting start status can be checked on the LCD.

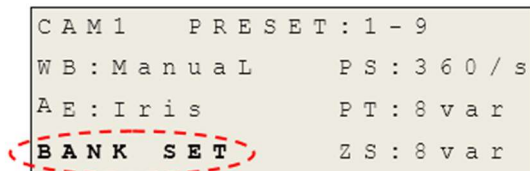

Ⓒ Press the desired number buttons sequentially.

- The status of the selected number can be checked on the LCD.

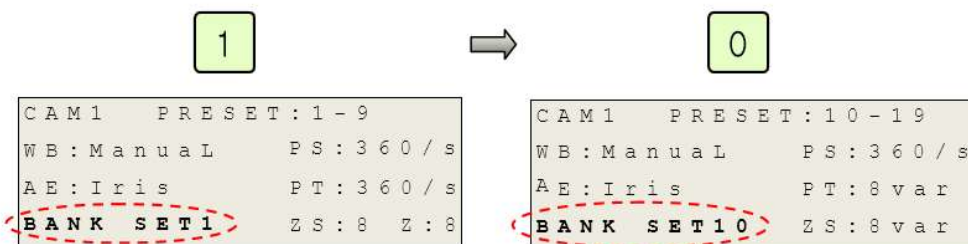

Ⓓ Press the BANK button. The BANK button is turned off and the setting is completed.

- BANK setting completion status can be checked on the LCD.

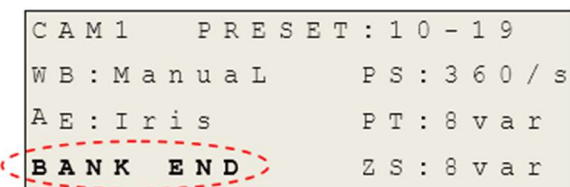

Ⓔ If you set the wrong bank, it returns to the previously set bank and displays an error on the LCD.



(ex) 120 Bank setting: Press the BANK button, 1, 2, 0, BANK button sequentially.

Focus & Zoom mode Settings

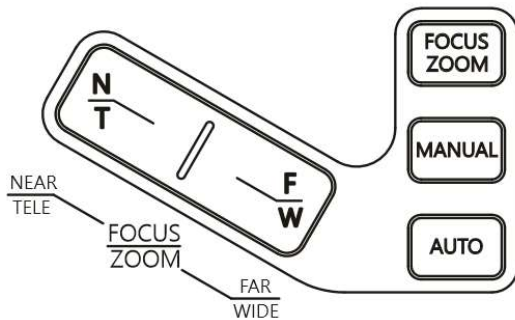

1) FOCUS/ZOOM (PATENTED)

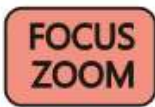
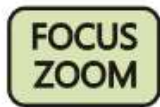

- To change the function, press and hold for 3 seconds until the FOCUS ZOOM button flashes.

- Used to change the focus and zoom function with joystick or button.

- When the FOCUS ZOOM button is green, the NEAR/FAR and TELE/WIDE buttons perform the focus function and the joystick knob performs the zoom function.

- When the FOCUS ZOOM button is red, the NEAR/FAR and TELE/WIDE buttons perform the zoom function and the joystick knob performs the focus function.

2) NEAR/FAR, TELE/WIDE

- Used to perform focus NEAR/FAR or zoom TELE/WIDE function.

- When the FOCUS ZOOM button is green, the NEAR/FAR function of the focus is activated. (MANUAL)

- When the FOCUS ZOOM button is red, the TELE/WIDE function is activated.

3) MANUAL



- Used to set the camera's focus to MANUAL.

4) AUTO



- Used to set the camera's focus to AUTO.

* The NEAR/FAR key does not work in this mode.

Camera Setting

1) SHIFT

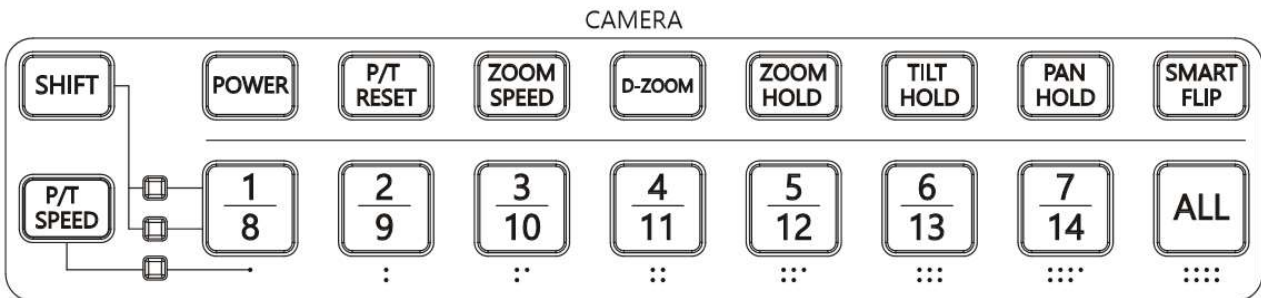

- SHIFT** - Used to change the camera ID selection to 1 ~ 7 or 8 ~ 14.
- SHIFT** - Press the SHIFT button repeatedly to change the mode to 1 ~ 7 or 8 ~ 14.
- SHIFT** (It can be checked by the illuminated indicator above and below.)

2) P/T SPEED (P/T SPEED + Number or ALL)

- P/T SPEED** - Used to change the camera up / down / left / right movement speed.
- P/T SPEED** - You can set the movement speed in 8 levels.
- P/T SPEED** - It can be set differently for each camera ID.
- P/T SPEED** - The dot at the bottom of the camera ID button indicates the moving speed.

P/T SPEED Setup

- Select the ID of the camera you want to change.
- Press the P/T SPEED button.
 - Confirm that the number button of the currently set speed is turned on.
 - The currently set speed can be checked on the LCD.

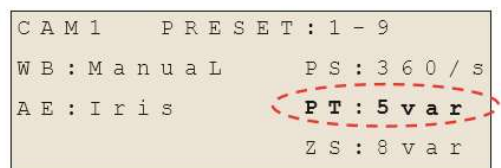
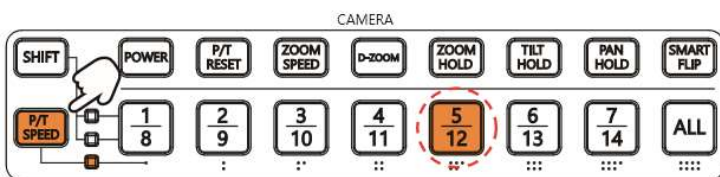

- Press the number button for the desired speed.

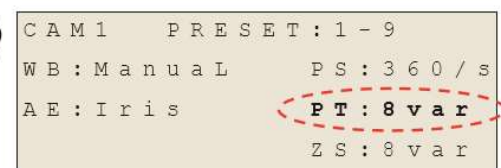
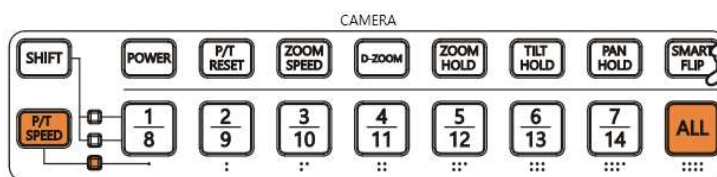

3) POWER (POWER + Number)



- By selecting the camera ID 1 ~ 7 or 8 ~ 14 with the SHIFT button, you can check the power on / off of 7 cameras and the connection with the controller.

- Used to turn on or off the selected camera ID.

Check Power On, Off status & Connection status with Controller

① Press the SHIFT button repeatedly to select camera ID range 1 ~ 7 or 8 ~ 14 to check.

② Press the POWER button.

- When the camera ID is On, it turns on and when the camera ID in the standby status, it blinks.

-The camera ID turns off when the connection with the controller is lost, or the controller can not be checked due to the setting error of protocol, Baudrate, etc.

- The figure below shows that camera ID 1 and 5 are connected. (You can check the status on the LCD.)

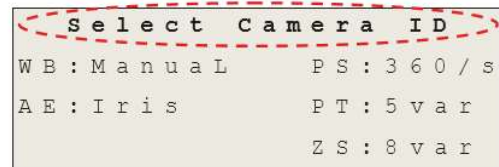
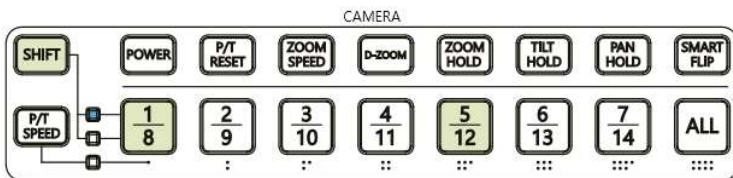

Power On, Off Setup

① Press the SHIFT button repeatedly to select camera ID range 1 ~ 7 or 8 ~ 14 to check.

② Press the POWER button and check the connection with the camera.

③ While holding the POWER button, press the camera ID button.

- When the camera ID button is lit(On), the camera turns off and the selected camera ID button blinks.

- When the camera ID button blinks(Off), the camera turns on and the selected camera ID button blinks.

- The camera ID button that is not lit or blinking is selected after checking the camera connection status.

4) P/T RESET (P/T RESET + Number)



- Used to initialize the selected camera ID's Pan and Tilt location.

- Use the SHIFT button to select camera ID 1 to 7 or 8 to 14 to check the connection to the seven resettable cameras and the connection status with the controller.

Check the connection to the camera and controller that can be initialized

① Press the SHIFT button repeatedly to select camera ID range 1 ~ 7 or 8 ~ 14 to check.

② Press the P/T RESET button.

- The resettable camera ID button lights up.

-The camera ID turns off when the connection with the controller is lost, or the controller can not be checked due to the setting error of protocol, Baudrate, etc.

- The figure below shows that camera ID 1 and 5 are connected. (You can check the status on the LCD.)

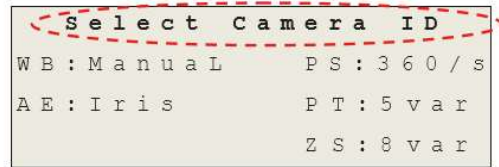
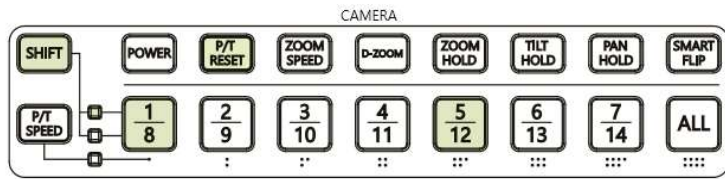

Initialization

- Ⓐ Press the SHIFT button repeatedly to select camera ID range 1 ~ 7 or 8 ~ 14 to check.
- Ⓑ Press the P/T RESET button and check the connection status to the camera.
- Ⓒ Hold the P/T RESET button and press the camera ID button.
 - The camera ID button that is not lit is selected after confirming the camera status.

5) ZOOM SPEED (ZOOM SPEED + Number or ALL)

- ZOOM SPEED** - Used to change the moving speed of the Zoom (Tele and Wide).
- It can be set differently for each camera ID.
- You can set the movement speed in 8 levels.

- The dot at the bottom of the camera ID button indicates the moving speed
- If you press the ZOOM SPEED button, the currently set zoom speed button lights up.
- The currently set zoom speed can be checked on the LCD.

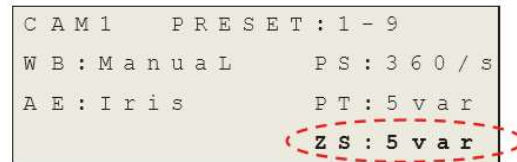
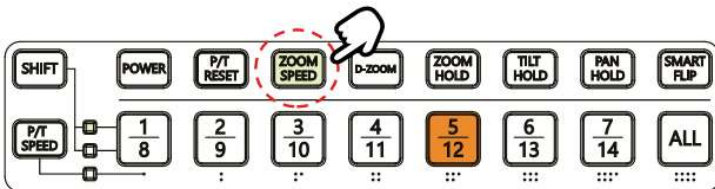

Zoom movement speed setup

- Ⓐ While holding the ZOOM SPEED button, press the desired zoom speed number button.
- The currently set zoom speed can be checked on the LCD.

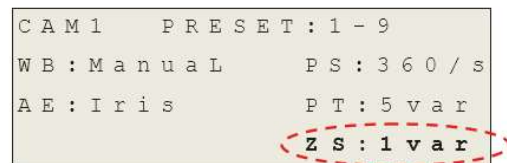
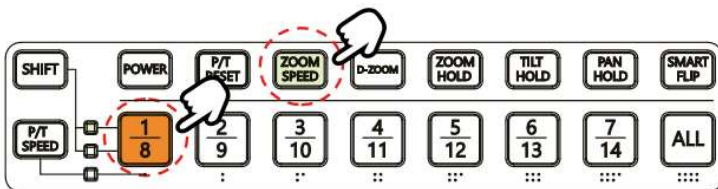

6) D-ZOOM

D-ZOOM

- Used to select the digital zoom function.

- You can check the digital zoom On, Off status of the camera.

- Turns on when the digital zoom function is on, and turns off when it is off.

7) ZOOM HOLD

**ZOOM
HOLD**

- Used to hold the current movement of the Zoom.

8) TILT HOLD

**TILT
HOLD**

- Used to hold the current movement of the Tilt.

9) PAN HOLD

**PAN
HOLD**

-Used to hold the current movement of the Pan.

10) SMART FLIP

**SMART
FILP**

- Used to check the camera's SMART FLIP status.

- Lights up when the Tilt exceeds 90 °.

Camera Control



- Used to move the camera up / down / left / right, and control zoom or focus, and move to the HOME.
- When the FOCUS ZOOM button is green, rotate the joystick clockwise / counterclockwise to control the zoom. When the FOCUS ZOOM button is red, rotate the joystick clockwise / counterclockwise to adjust the focus. (PATENTED)
- In the OSD of the camera and controller, it is used to move up and down the cursor and select the changed setting value.

Menu Control

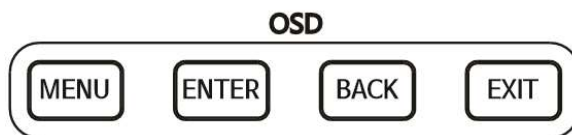

1) MENU

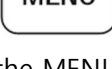
-  - Press the MENU button shortly to enter the camera's OSD and the MENU button will be lit.
-  - Press and hold the MENU button for 3 seconds to enter the menu for controller setting and the MENU button will blink.

2) ENTER

-  - Used to save the set values from the menu of camera and controller.

3) BACK

-  - Used to cancel the set value in the menu of camera and controller or used to return to the previous screen.

4) EXIT

-  - Used to exit the camera and controller menu.

Controller Menu Tree

- Below is the menu tree of the controller.

| Main menu | 1st Sub-menu | 2nd Sub-menu | 3rd Sub-menu | 4th Sub-menu | |
|------------------------------------|--------------------------------------|--------------------------|---------------------------------------|---------------------------------------|--|
| Protocol | VISCA/ VISCA IP /SONY IP | | | | |
| Interface (VISCA IP/SONY IP) | DHCP/ Static | | | | |
| <IP Setting> (VISCA IP/SONY IP) | <Control IP SETUP> | IP(x.x.x.x) | 192.168.000.12 (x : 0~255,) | | |
| | | Netmask(x.x.x.x) | 255.255.255.000 (x : 0~255) | | |
| | | Gatway(x.x.x.x) | 192.168.000.1 (x : 0~255) | | |
| | | PORT(y) | 49153 (y : 0~65535) | | |
| | | CONFIRM | Yes/ No | | |
| | <Camera IP SETUP> | <CAMERA IP VEIW> | | CAM 1~14 IP View | |
| | | IP(x.x.x.x) | | 000.000.000.000 (x : 0~255) | |
| | | PORT(y) | | 52381 (y : 0~65535) | |
| | <MAC ADDRESS> | xx:xx:xx:xx:xx:xx | | | |
| | Baudrate (VISCA) | 9600bps /38400bps | | | |
| Interface (VISCA) | RS-422 / RS-232C | | | | |
| Jog Sens. | 1~ 5 ~8 | | | | |
| Pan Dir | Normal / Inverse | | | | |
| Backlight | On/ 1min /10min~60min/ Off | | | | |
| Buzzer | On / Off | | | | |
| (Additional setup) | Model | ***_*200 | | | |
| | F/W ver. | X.XX*200 | | | |

| | | | | |
|--|---------------------|----------------------|----------------|-------|
| | Alarm CAMxx | On/ Off | | |
| | <System Initialize> | Factory Reset | No /Yes | |
| | | < Joystick Calibra.> | Calibration | P/T/Z |

- The letters in the **boldface** indicate the initial settings.

Controller Menu Setting

- Press and hold the MENU button for 3 seconds to enter the controller setup menu. (At this time, the MENU button blinks.)
- The menu entry status can be checked on the LCD.

```

System Setup # 1
Protocol      : V I S C A
→ Baudrate   9 6 0 0 b p s
Interface     R S - 4 2 2

```

- Use the joystick to move within the menu.
- As you move down, the menu displayed inside < > has more submenus.
- Use the joystick UP / DOWN to move the cursor between items within the setup menu.
- Use the joystick UP / DOWN to change the setting value.
- Press the ENTER or HOME button to save the changed setting value, or use the BACK button to return to the previous step or cancel.

1) Baudrate

- Used to set the Baudrate with the camera. Available rates are 9600bps and 38400bps.

2) Interface

- Used to set the communication with the camera. RS-232C and RS-422 can be set.

```

System Setup # 2
→ Jog Sens .    5
Pan Dir         N o r m a l
Backlight      1 m i n

```

3) Jog Sensitivity

- Used to set the sensitivity of the first movement in the center of the joystick.
- Sensitivity can be set from 1 to 8, which is the most sensitive when set to 1, and the least sensitive when set to 8.

4) Pan Direction

- Used to change the direction of the Pan on the camera. If it is normal, the operation direction of the joystick matches the operation direction of the camera. If it is Inverse, the movement direction of the camera changes in the opposite direction to that of the joystick.

5) Backlight

- Used to change the LCD backlight retention time.
- When set to On, it is always maintained. When it is set to Off, backlight is always Off.

```
System Setup # 3
→ Buzzer      On
  <Additional Setup>
```

- Settable time range is from 1min. to 60min. and the backlight is off after the selected time elapses.

6) Buzzer

- Used to activate/ deactivate the buzzer.
- The buzzer is a function that informs the user when the menu is on and off, and when the operation exceeds the controller's operation range.

7) Class

- This function allows you to control additional 14 cameras per a class
- 14 cameras * 14 classes means 196 cameras can be controlled by one remote controller.

8) <Additional Setup>

- In the submenu, used to display model name and F/W version of the controller. And used to initialize the controller and adjust the origin point of the joystick.

```
Additional Setup # 1
Model          : TVR-200H
F/W ver.      : 1.XXKA200
→ Alarm CAMxx Off
```

7.1) Model

- Displays the model name of the controller.

7.2) F/W .rev

- Displays the Firmware version that is the software version of the controller.

7.3) Alarm CAMxx

- This function operates when the power of camera and RM is applied.

- Alarm is set to notify of the error or prevent loss when communication with the camera is lost.

- When the setting of the controller and camera is completed and the Alarm is turned on, if the main power of the camera is turned off or communication is not made, the camera is considered to be in error or lost and an alarm is sounded.

```
A d d i t i o n a l   S e t u p   # 2  
→ < S y s t e m   I n i t i a i i z e >
```

7.4) <System Initialize>

- Used to initialize the controller and adjust the origin point of the joystick.

```
S y s t e m   I n i t i a i i z e  
→ F a c t o r y   R e s e t   N o  
   < J o y s t i c k   C a l i b r a . >
```

7.4.1) Factory Reset

- Initializes the controller to factory default state.

7.4.2) Joystick Calibration

* This setting is service related. A malfunction may occur when changing the value.

- Used to adjust the origin point of the joystick in the submenu.

* After all the connected cameras have completed self-diagnosis, start the adjustment.

Dimensions (unit: mm)

TOP View

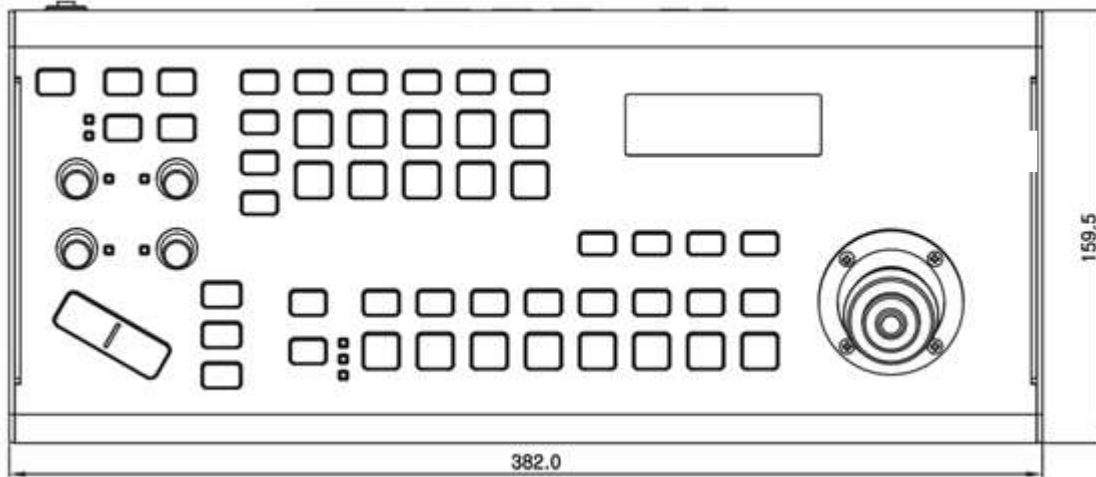

SIDE View

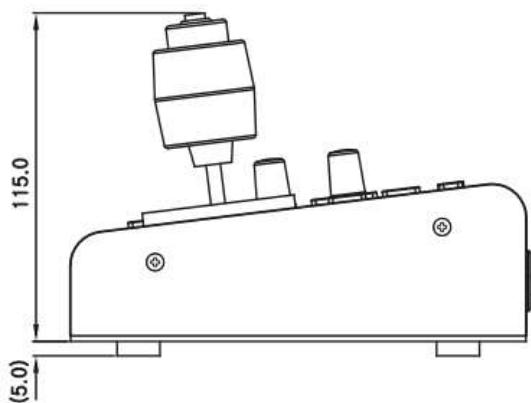

REAR View

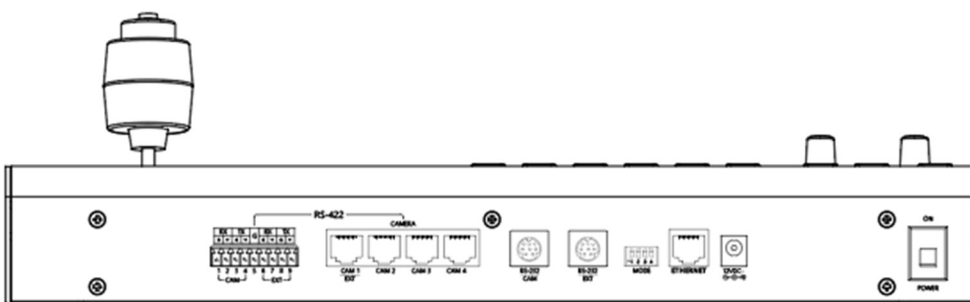

Specifications

| | |
|-----------------------|---|
| In/Out Put | RS-422/232C : 9 Pin, RJ-45/Mini Din 8P Connector (VISCA Protocol compatibility) IP : RJ-45 Connector(Protocol : VISCA IP, SONY IP) |
| Data Rate | 9600 bps/ 38400 bps |
| Power/Current | DC IN 12V \pm 10% / 1A |
| Weight | Approximately 1.4 Kg |
| Operating temperature | 0 $^{\circ}$ C ~40 $^{\circ}$ C |
| Accessory | <p>User Manual, Installation Manual 232C/ 422 Pin Connector AC Power Code AC Power Adaptor</p>  |

KTM-100 (Optional)

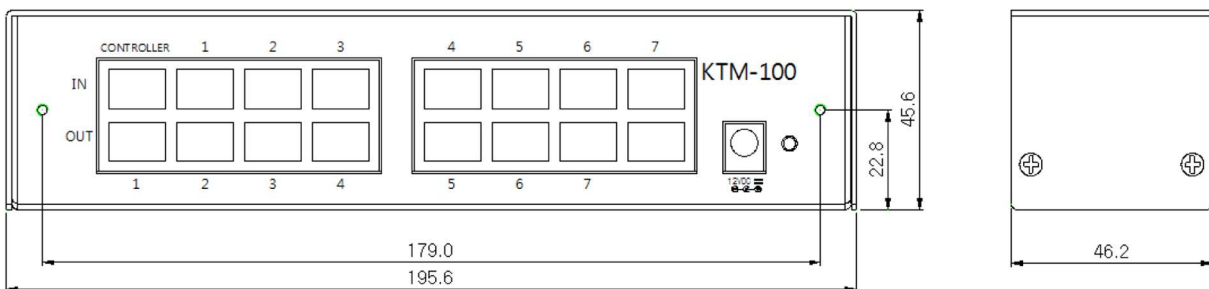

MEMO

A large, empty rectangular box with rounded corners, intended for writing a memo. The box is defined by a thin black border and occupies most of the page below the 'MEMO' header.

MEMO

A large, empty rectangular box with rounded corners, intended for writing a memo. The box is defined by a thin black border and occupies most of the page below the 'MEMO' header.

MEMO

A large, empty rectangular box with rounded corners, intended for writing a memo. The box is defined by a thin black border and occupies most of the page below the 'MEMO' header.



www.salrayworks.com

Unit 905, 1126 Beoman-ro, Geumchoeon-Gu, Seoul, Korea 08595

anyhelp@salrayworks.com